



# TORNATECH

Project: \_\_\_\_\_

Customer: \_\_\_\_\_

Engineer: \_\_\_\_\_

Pump Manufacturer: \_\_\_\_\_

## Technical Data Submittal Document

# GPx Foam Series

Full Service

Electric Additive (Foam) Pump Controller



### Contents:

Data Sheets

Dimensional Data

Wiring Schematics

Field Connections

**Note:** The drawings included in this package are for controllers covered under our standard offering. Actual AS BUILT drawings may differ from what is shown in this package.



March 2024

### Select starting method

#### Model GPA Across the line

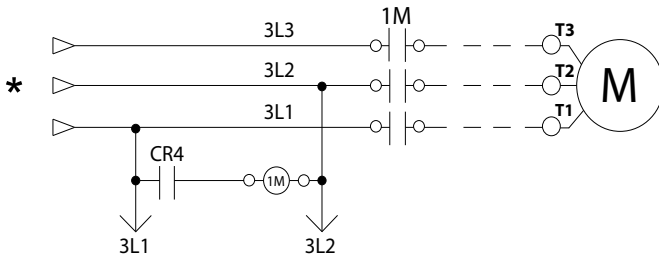

#### Model GPY Wye-Delta Open

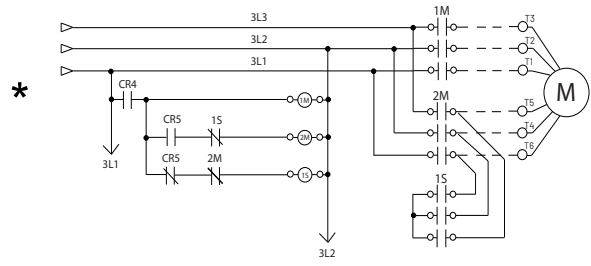

\*From normal incoming power through Disconnecting Means (IS/CB)



### GPx Foam Series Electric Additive (Foam) Pump Controller

<b>Standard, Listings, Approvals and Certifications</b>	<b>Built to NFPA 20</b>		
	<b>Underwriters Laboratory (UL)</b>	UL218 - Fire Pump Controllers	
	<b>FM Global</b>	Class 1321/1323	
	<b>CE Mark</b>	Various EN, IEC & CEE directives and standards	
	Built in Canada or U.A.E	Built in Europe	
	CE Mark Option	Supplied as Standard	
<b>Enclosure</b>	<b>Protection Rating</b>		
	Built in Canada or U.A.E	Built in Europe	
	Standard: NEMA 2	Standard: IP55	
	<b>Optional</b>		
	NEMA 12	NEMA 4X-304 sst painted	IP54
	NEMA 3	NEMA 4X-304 sst brushed finish	IP55
	NEMA 3R	NEMA 4X-316 sst painted	IP65
	NEMA 4	NEMA 4X-316 sst brushed finish	IP66
	<b>Accessories</b> • Bottom entry gland plate • Lifting Lugs • Keylock handle	<b>Paint Specifications</b> • Red RAL3002 • Powder coating • Glossy textured finish	

<b>Additive (Foam) Pump Controllers</b>	<p><b>Choose one of the following configurations:</b></p> <p>A8 - Additive (Foam) pump controller / non pressure actuated without pressure transducer and run test solenoid valve</p> <p>A8A - Additive (Foam) pump controller with pressure transducer and run test solenoid valve</p> <p>A8B - Additive (Foam) pump controller with pressure transducer and run test solenoid valve in stainless steel</p>
	<p><b>Add any of the following options if required:</b></p> <p>D40 - Dump valve circuitry, 24VDC Max2A</p> <p>Cx79 - Low foam additive level complete with visual indication and alarm contact (DPDT)</p> <p>Cx081 - Provision for proof pressure switch for low additive pressure complete with visual indication and alarm contact. (Proof pressure switch provided by others.)</p>



**Technical Data**  
**GPx Foam Series Electric Additive (Foam)**  
**Pump Controller**

Shortcircuit Withstand Rating	200V to 208V 60Hz	220V to 240V 60Hz	380V to 415V 50 Hz / 60Hz	440V to 480V 60Hz	575V to 600V 60Hz
	HP (kw)				
Standard 100kA	5 - 150 (3.7 - 110)	5 - 200 (3.7 - 149)	5 - 300 (3.7 - 223)	5 - 400 (3.7 - 298)	N/A
Optional 150kA					
Standard 50kA	200 (149)	250 (186)	350 - 450 (261-335)	450 - 500 (335 - 373)	5 - 500 (3.7 - 373)
Optional 100kA	N/A	N/A	350 - 500 (261 - 373)	450 - 500 (335 - 373)	
Optional 200kA	5 - 150 (3.7 - 110)	5 - 200 (3.7 - 149)	5 - 300 (3.7 - 223)	5 - 400 (3.7 - 298)	N/A

<b>Ambient Temperature Rating</b>	<b>Standard:</b> 4°C to 40°C / 39°F to 104°F  <b>Optional:</b> 4°C to 55°C / 39°F to 131°F  Controllers built in Dubai, UAE (Tornatech FZE) are supplied standard with 55°C rating.
<b>Surge Suppression</b>	Surge arrestor rated to suppress surges above line voltage
<b>Disconnecting Means</b>	<ul style="list-style-type: none"> <li>Isolating switch and circuit breaker assembly:               <ul style="list-style-type: none"> <li>Door interlocked in the ON position</li> <li>Isolating switch rated not less than 115% of motor full load current</li> <li>Circuit breaker continuous rating not less than 115% of motor full load current</li> <li>Overcurrent sensing non-thermal type, magnetic only</li> <li>Instantaneous trip setting of not more than 20 times the motor full load current</li> </ul> </li> <li>Common flange mounted operating handle</li> </ul>
<b>Service Entrance Rating</b>	Suitable as service entrance equipment
<b>Emergency Start Handle</b>	<ul style="list-style-type: none"> <li>Flange mounted</li> <li>Integrated limit switch</li> <li>Pull and latch activation</li> <li>Across the line start (direct on line)</li> </ul>
<b>Locked Rotor Protector</b>	<ul style="list-style-type: none"> <li>Operate shunt trip to open circuit breaker</li> <li>Factory set at 600% of motor full load current</li> <li>Trip between 8 and 20 seconds</li> </ul>
<b>Electrical Readings</b>	<ul style="list-style-type: none"> <li>Voltage phase to phase (normal power)</li> <li>Amperage of each phase when motor is running</li> </ul>
<b>Pressure Readings</b>	<ul style="list-style-type: none"> <li>Continuous system pressure display</li> <li>Cut-in and Cut-out pressure settings</li> </ul>
<b>Pressure and Event recorder</b>	<ul style="list-style-type: none"> <li>Pressure readings with date stamp</li> <li>Event recording with date stamp</li> <li>Under regular maintained operation, events are stored in memory for the life of the controller.</li> <li>Data viewable on operator interface display screen</li> <li>Downloadable by USB port to external memory device</li> </ul>
<b>Pressure Sensing</b>	<ul style="list-style-type: none"> <li>Pressure transducer and run test solenoid valve assembly for fresh water application</li> <li>Pressure sensing line connection 1/2" Female NPT</li> <li>Drain connection 3/8"</li> <li>Rated for 0-500PSI working pressure (standard display at 0-300PSI)</li> <li>Externally mounted with protective cover</li> </ul>



**Technical Data**  
**GPx Foam Series Electric Additive (Foam)**  
**Pump Controller**

<b>Audible Alarm</b>	Alarm buzzer - 85dB at 3 meters
<b>Visual Indications</b>	<ul style="list-style-type: none"> <li>• Power available</li> <li>• Motor run</li> <li>• Periodic test</li> <li>• Manual start</li> <li>• Deluge valve start</li> <li>• Remote automatic start</li> <li>• Remote manual start</li> <li>• Emergency start</li> <li>• Pump on demand/Automatic start</li> <li>• Pump room temperature (°F or °C)</li> <li>• Lockout</li> </ul>
<b>Visual &amp; Audible Alarms</b>	<p>Visual</p> <ul style="list-style-type: none"> <li>• Control voltage not healthy</li> <li>• Invalid cut-in</li> <li>• Lock rotor current</li> <li>• Loss of power</li> <li>• Low ambient temperature</li> <li>• Low water level</li> <li>• Motor trouble</li> <li>• Phase reversal (normal power)</li> <li>• Overcurrent</li> <li>• Overvoltage</li> <li>• Phase loss L1</li> <li>• Phase loss L2</li> <li>• Phase loss L3</li> <li>• Phase unbalanced</li> <li>• Pressure transducer fault detected</li> <li>• Pump on demand</li> <li>• Pump room alarm</li> <li>• Service required</li> <li>• Undercurrent</li> <li>• Undervoltage</li> <li>• Check weekly test solenoid</li> <li>• Weekly test cut-in reached</li> </ul> <p>Visual and audible</p> <ul style="list-style-type: none"> <li>• Fail to start</li> </ul>
<b>Remote Alarm Contacts</b>	<p>DPDT-8A-250V.AC</p> <ul style="list-style-type: none"> <li>• Power available</li> <li>• Phase reversal</li> <li>• Motor run</li> <li>• Common pump room alarm (field re-assignable)** <ul style="list-style-type: none"> <li>• Overvoltage</li> <li>• Undervoltage</li> <li>• Phase unbalance</li> <li>• Low pump room temperature</li> <li>• High Pump room temperature</li> </ul> </li> <li>• Common motor trouble (field re-assignable)** <ul style="list-style-type: none"> <li>• Overcurrent</li> <li>• Fail to start</li> <li>• Undercurrent</li> <li>• Ground fault</li> </ul> </li> <li>• Free (field programmable)**</li> </ul>

\*\*Tornatech reserves the right to use any of these three alarm points for special specific application requirements.



<b>ViZiTouch V2.1 Operator Interface</b>	<ul style="list-style-type: none"> <li>• Embedded microcomputer with software PLC logic</li> <li>• 7.0" color touch screen (HMI technology)</li> <li>• Upgradable software</li> <li>• Multi-language</li> </ul>			
<b>Communication Protocol Capability</b>	<ul style="list-style-type: none"> <li>• Protocol: Modbus</li> <li>• Connection type: Shielded female connector RJ45</li> <li>• Frame Format: TCP/IP</li> <li>• Addresses: See bulletin MOD-GPx</li> </ul>			
<b>Operation</b>	<b>Automatic Start</b>	<ul style="list-style-type: none"> <li>• Start on pressure drop</li> <li>• Remote start signal from automatic device</li> <li>• Deluge valve start</li> </ul>		
	<b>Manual Start</b>	<ul style="list-style-type: none"> <li>• Start pushbutton</li> <li>• Run test pushbutton</li> <li>• Remote start from manual device</li> </ul>		
	<b>Stopping</b>	<ul style="list-style-type: none"> <li>• Manual with Stop pushbutton</li> <li>• Automatic after expiration of minimum run timer ***</li> </ul>		
	<b>Timers</b>	Field Adjustable & Visual Countdown	<ul style="list-style-type: none"> <li>• Minimum run timer ***(off delay)</li> <li>• Sequential start timer (on delay)</li> <li>• Periodic test timer</li> </ul>	
	<b>Actuation</b>	Visual Indication	<ul style="list-style-type: none"> <li>• Pressure</li> <li>• Non-pressure</li> </ul>	
	<b>Mode</b>		<ul style="list-style-type: none"> <li>• Automatic</li> <li>• Non-automatic</li> </ul>	

\*\*\*Can only be used if approved by the AHJ



**Technical Data  
GPx Foam Series Electric Additive (Foam)  
Pump Controller**

A4	Flow switch provision	C19	Emergency start alarm contact (DPDT)
A9	Low zone pump control function	C20	Manual start alarm contact (DPDT)
A10	Middle zone pump control function	C21	Deluge valve start alarm contact (DPDT)
A11	High zone pump control function	C22	Remote automatic start alarm contact (DPDT)
A13	Non-pressure actuated controller w/o pressure transducer and run test solenoid valve	C23	Remote manual start alarm contact (DPDT)
A16	Lockout/interlock circuit from equipment installed inside the pump room	C24	High pump room temperature alarm contact (DPDT)
B11	Built in alarm panel (120V.AC supervisory power) providing indication for: • Audible alarm & silence pushbutton for motor run, phase reversal, loss of phase. • Pilot lights for loss of phase & supervisory power available	C25	Second set of standard alarm contacts (DPDT) (Typical for city of Los Angeles and Denver)
B11B	Built in alarm panel same as B11 but 220-240VAC supervisory power	Cx	Additional visual and alarm contact (Specify function) (DPDT)
B19A	High motor temperature c/w thermostat relay and alarm contacts (DPDT)	D1	Low suction pressure transducer for fresh water rated at 0-300PSI with visual indication and alarm contact
B19B	High motor temperature c/w PT100 relay and alarm contacts (DPDT)	D1A	Low suction pressure transducer for sea water rated at 0-300PSI with visual indication and alarm contact
B21	Ground fault alarm detection c/w visual indication and alarm contact (DPDT)	D5	Pressure transducer and run test solenoid valve for fresh water rated for 0-500PSI (for factory calibration purposes only)
C1	Extra motor run alarm contact (DPDT)	D5D	Pressure transducer and run test solenoid valve for sea water rated for 0-500PSI
C4	Periodic test alarm contact (DPDT)	D10	Omit mounting feet (when applicable)
C6	Low discharge pressure alarm contact (DPDT)	D13	High withstand rating for: • 200V to 208V @ 150HP max. = 150kA* • 200V to 208V @ 200HP = 100kA* • 220V to 240V @ 200HP max. = 150kA* • 220V to 240V @ 250HP = 100kA* • 380V to 415V @ 300HP max. = 150kA* • 380V to 415V @ 350HP to 450HP = 100kA* • 440V to 480V @ 400HP max. = 150kA* • 440V to 480V @ 450HP to 500HP = 100kA* • 600V @ 500HP max. = 100kA*
C7	Low pump room temperature alarm contact (DPDT)	D13A	High withstand rating for: • 380V to 480V = 65kA* • 600V = 25kA*
C10	Low water reservoir level alarm contact (DPDT)	D13B	High withstand rating for: • 200V to 208V @ 150HP max. = 200kA* • 220V to 240V @ 200HP max. = 200kA* • 380V to 415V @ 300HP max. = 200kA* • 440V to 480V @ 400HP max. = 200kA*
C11	High electric motor temperature alarm contact (DPDT)	D14	Anti-condensation heater & thermostat
C12	High electric motor vibration c/w visual indication and alarm contact (DPDT)	D14A	Anti-condensation heater & humidistat
C14	Pump on demand / automatic start alarm contact (DPDT)	D14B	Anti-condensation heater & thermostat & humidistat
C15	Pump fail to start alarm contact (DPDT)		
C16	Control voltage healthy alarm contact (DPDT)		
C17	Flow meter valve loop open c/w visual indication and alarm contact (DPDT)		
C18	High water reservoir level c/w visual indication and alarm contact (DPDT)		

\*For fire pump controller section only.

Note: Options chosen from this page are not electrically represented on the wiring schematics in this submittal package.



D15	Tropicalization
D18	CE Mark with factory certificate
D26	Modbus with RTU frame format and RS485 connection
D27	Motor heater connection (external single phase power source and heater on/off contact)
D27A	Motor heater connection (internal single phase power source and heater on/off contact)
D28	Customized drawing set
D34A	Field programmable I/O board - 5 Input / 5 output
D43	Seismic Certification compliant to CBC 2019, IBC 2018 rigid base/wall mounted only
D44	Special Seismic Certification compliant to OSHPD rigid base/wall mounted only

L01	Other language and English (bilingual)
L02	French
L03	Spanish
L04	German
L05	Italian
L06	Polish
L07	Romanian
L08	Hungarian
L09	Slovak
L10	Croatian
L11	Czech
L12	Portuguese
L13	Dutch
L14	Russian
L15	Turkish
L16	Swedish
L17	Bulgarian
L18	Thai
L19	Indonesian
L20	Slovenian
L21	Danish
L22	Greek
L23	Arabic
L24	Hebrew
L25	Chinese

Additional Options:

---



---



---



---



---

Note: Options chosen from this page are not electrically represented on the wiring schematics in this submittal package.



### ViZiTouch V2.1 Operator Interface

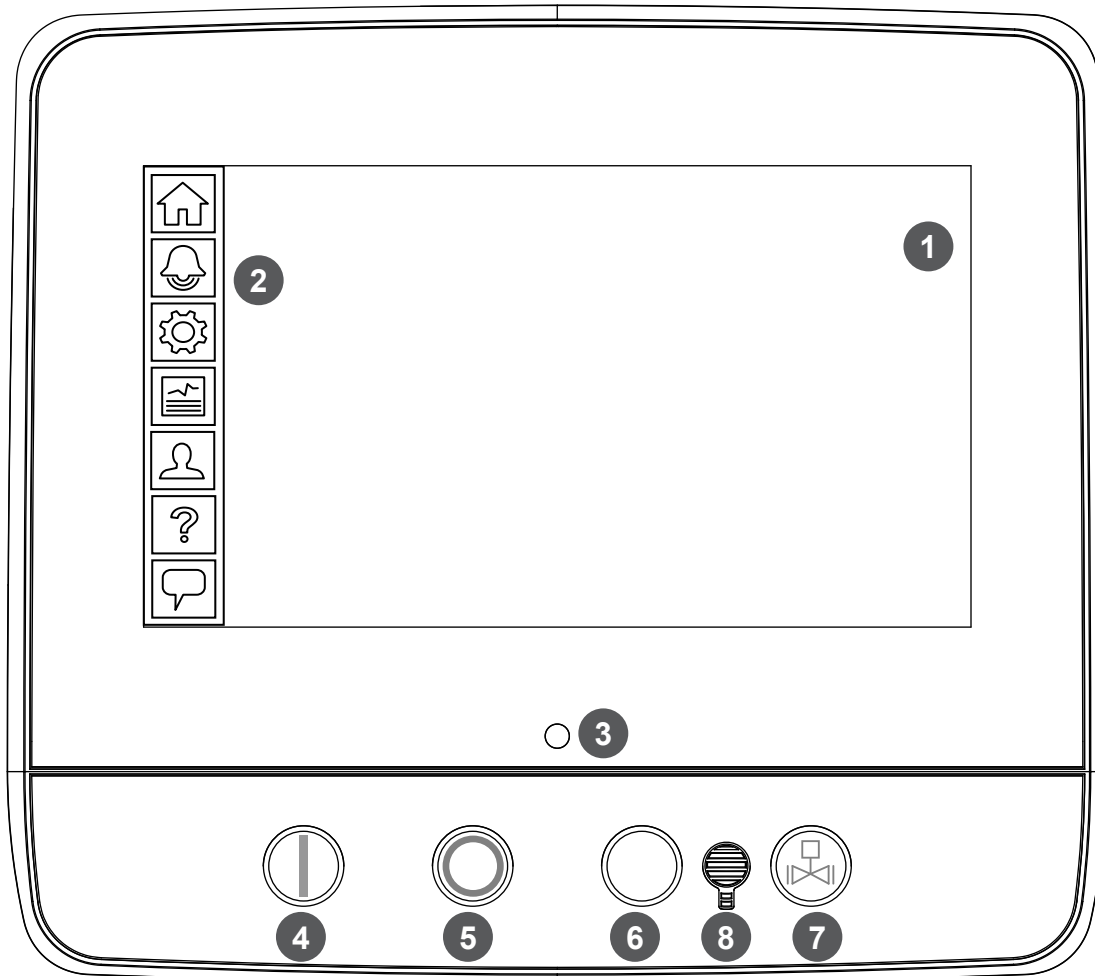

- |                        |                          |
|------------------------|--------------------------|
| 1 - Color touch screen | 3 - Power LED (3 colors) |
| 2 - Onscreen menu      | 4 - START button         |
| • HOME page            | 5 - STOP button          |
| • ALARM page           | 6 - Not Used             |
| • CONFIGURATION page   | 7 - RUN TEST button      |
| • HISTORY page         | 8 - Alarm buzzer         |
| • SERVICE page         |                          |
| • MANUAL page          |                          |
| • LANGUAGES page       |                          |



© Tornatech, Inc. Not for construction.  
Subject to change without notice.

	BY	DD/MM/YY
DRAWN BY	ZS	08/09/23
FINAL APPROVAL	FC	23/02/23

# ELECTRIC ADDITIVE (FOAM) PUMP CONTROLLER

**MODEL: GPA/GPY**

BUILT TO THE LATEST EDITION OF THE NFPA20 & NFPA70



DRAWING NUMBER	GPX-D1871/E
DWG REV. 0	
SHEET 1 OF 1	

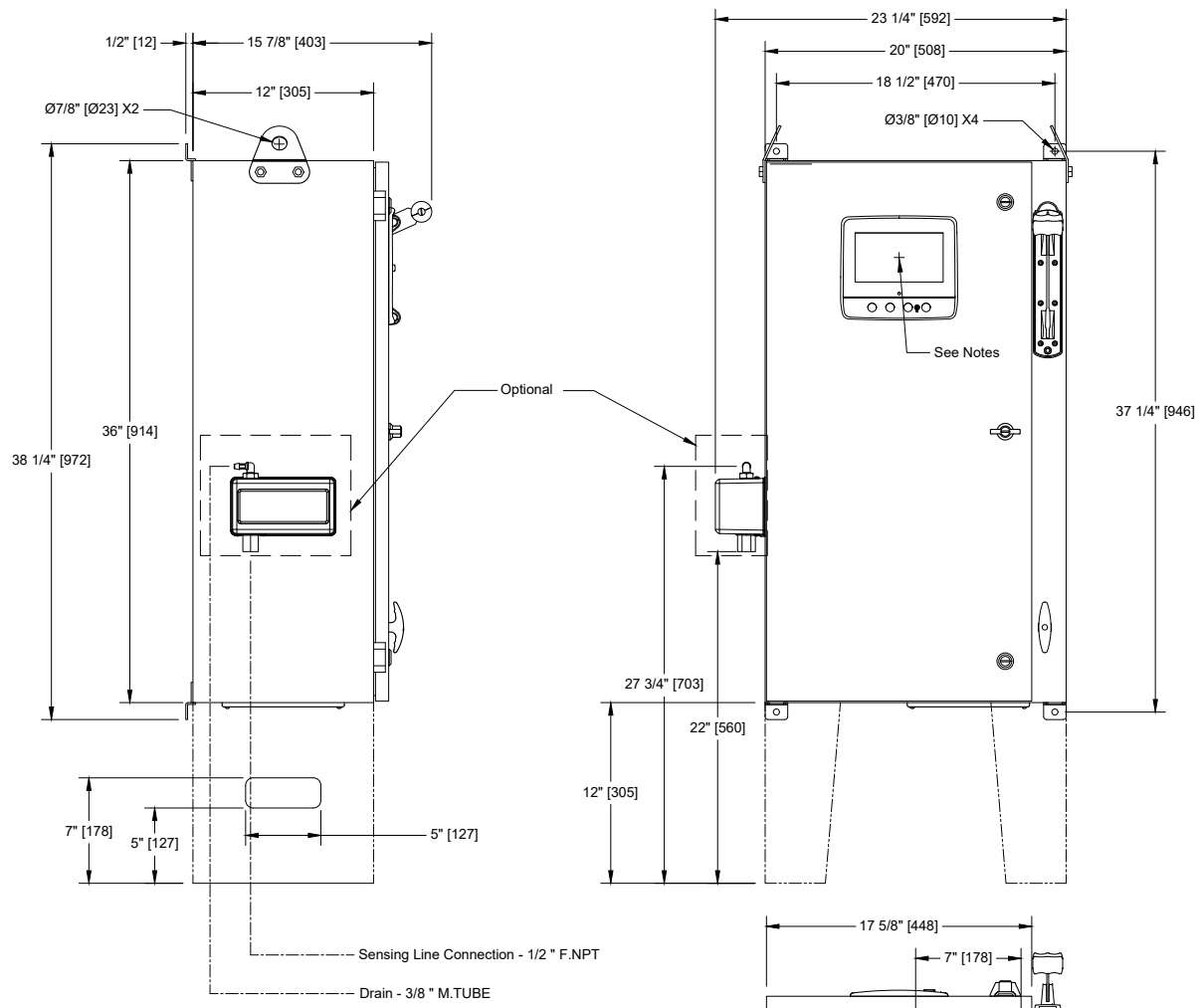

Voltage / Power Table		
Voltage	Min HP	Max HP
208	5	30
220 - 240	5	30
380 - 400 - 415	5	60
440 - 480	5	60
600	5	75

- Notes:**
- Standard: NEMA 2
  - Standard paint : textured red RAL 3002.
  - All dimensions are in inches [millimeters].
  - Center of screen: 29-5/8" [751] from bottom (no feet).
  - Bottom conduit entrance through removable gland plate recommended.
  - Use watertight conduit and connector only.
  - Protect equipment against drilling chips.
  - Door swing equal to door width.

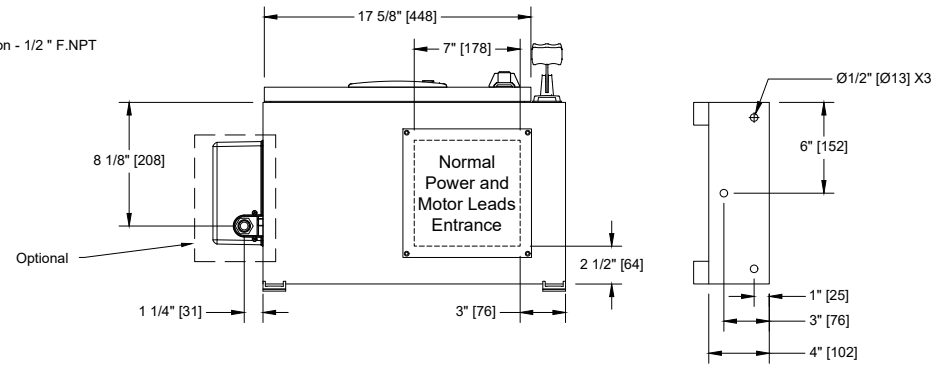



© Tornatech, Inc. Not for construction.  
Subject to change without notice.

	BY	DD/MM/YY
DRAWN BY	ZS	08/09/23
FINAL APPROVAL	FC	08/09/23

# ELECTRIC ADDITIVE (FOAM) PUMP CONTROLLER FULL VOLTAGE / ACROSS THE LINE

**MODEL:GPA**

BUILT TO THE LATEST EDITION OF THE NFPA20 & NFPA70



DRAWING NUMBER	GPA-WS870/E
DWG REV. 0	
SHEET 1 OF 2	

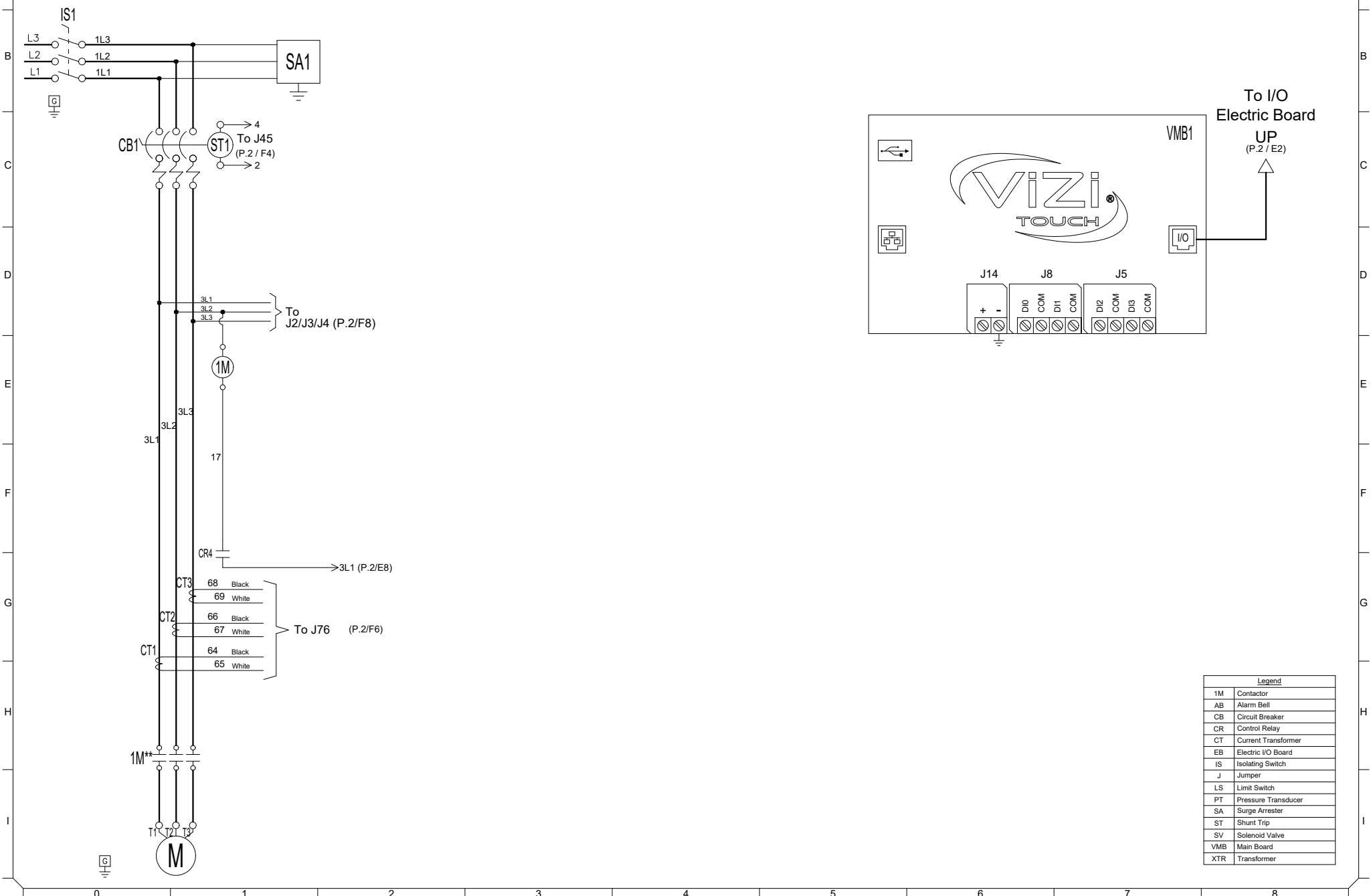

Legend	
1M	Contactor
AB	Alarm Bell
CB	Circuit Breaker
CR	Control Relay
CT	Current Transformer
EB	Electric I/O Board
IS	Isolating Switch
J	Jumper
LS	Limit Switch
PT	Pressure Transducer
SA	Surge Arrester
ST	Shunt Trip
SV	Solenoid Valve
VMB	Main Board
XTR	Transformer



© Tornatech, Inc. Not for construction.  
Subject to change without notice.

BY	DD/MM/YY
DRAWN BY	ZS 08/09/23
FINAL APPROVAL	FC 08/09/23

# ELECTRIC ADDITIVE (FOAM) PUMP CONTROLLER

## FULL VOLTAGE / ACROSS THE LINE

**MODEL:GPA**

BUILT TO THE LATEST EDITION OF THE NFPA20 & NFPA70



DRAWING NUMBER	GPA-WS870/E
DWG REV.	0
SHEET	2 OF 2

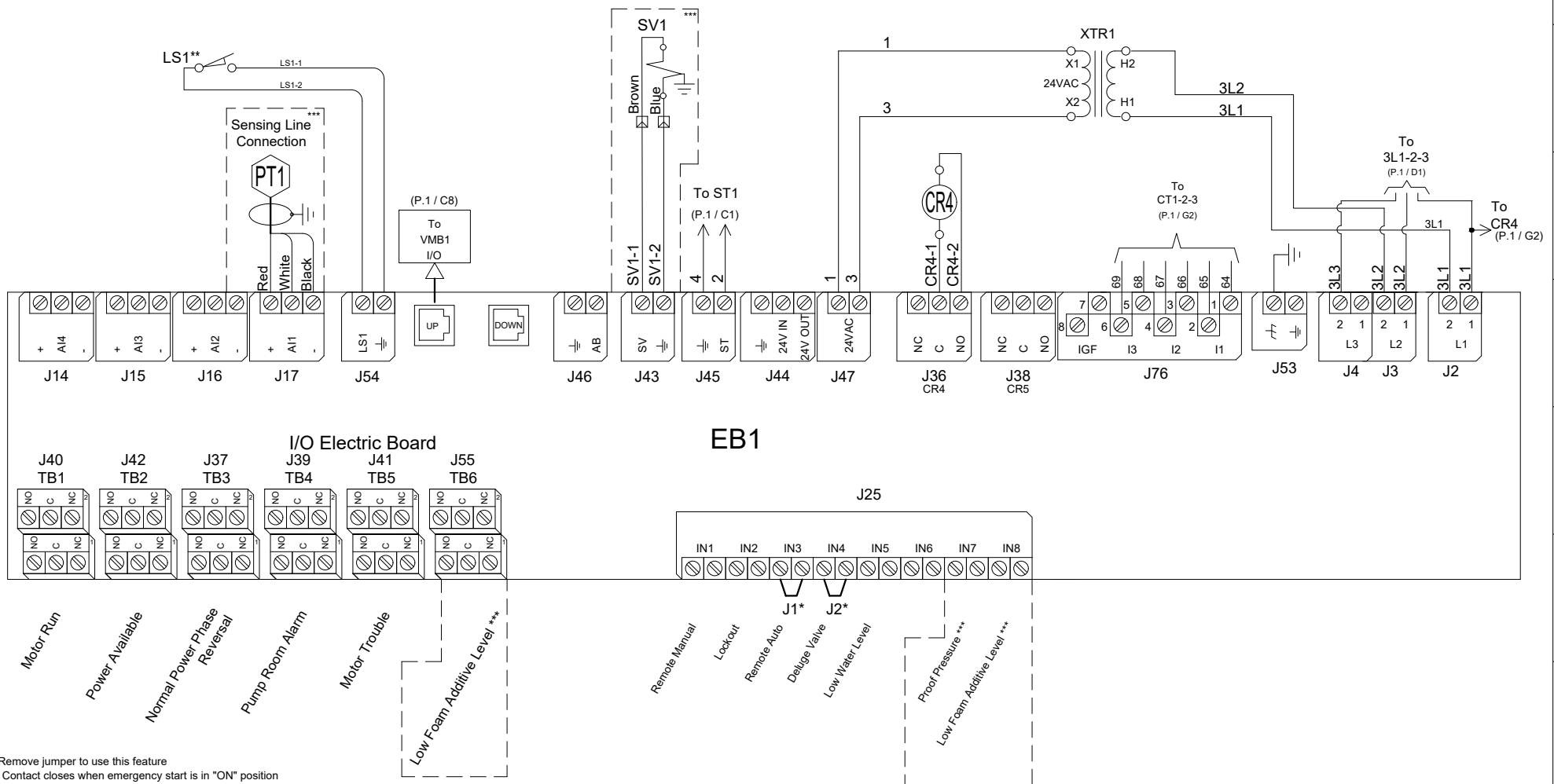

\* Remove jumper to use this feature  
 \*\* Contact closes when emergency start is in "ON" position  
 \*\*\* Optional



BY DD/MM/YY  
 DRAWN BY ZS 08/09/23  
 FINAL APPROVAL FC 08/09/23

# ELECTRIC ADDITIVE (FOAM) PUMP CONTROLLER

**MODEL:GPA/GPY**

BUILT TO THE LATEST EDITION OF THE NFPA20 & NFPA70



DRAWING NUMBER  
**GPX-TD870/E**  
 DWG REV. 0  
 SHEET 1 OF 1

© Tornatech, Inc. Not for construction.  
 Subject to change without notice.

## COPPER CONDUCTORS for Isolating Switch (IS1).

Field Wiring According to Bending Space (AWG or MCM). Terminals L1 - L2 - L3

Bending Space	5" (127 mm)							8" (203 mm)		
	HP Voltage	5	7.5	10	15	20	25	30	40	50
208	1x (10 to 1/0)	1x (8 to 1/0)	1x (8 to 1/0)	1x (6 to 1/0)	1x (4 to 1/0)	1x (3 to 1/0)	1x (2 to 1/0)	1x (1/0 to 3/0)	1x (3/0 to 250)	1x (4/0 to 250)
220 to 240	1x (10 to 1/0)	1x (10 to 1/0)	1x (8 to 1/0)	1x (6 to 1/0)	1x (4 to 1/0)	1x (4 to 1/0)	1x (3 to 1/0)	1x (1 to 3/0)	1x (2/0 to 3/0)	1x (3/0 to 250)
380 to 416	1x (10 to 1/0)	1x (10 to 1/0)	1x (10 to 1/0)	1x (8 to 1/0)	1x (8 to 1/0)	1x (6 to 1/0)	1x (6 to 1/0)	1x (4 to 1/0)	1x (3 to 1/0)	1x (3 to 1/0)
440 to 480	1x (10 to 1/0)	1x (10 to 1/0)	1x (10 to 1/0)	1x (10 to 1/0)	1x (8 to 1/0)	1x (8 to 1/0)	1x (6 to 1/0)	1x (6 to 1/0)	1x (4 to 1/0)	1x (3 to 1/0)
600	1x (10 to 1/0)	1x (10 to 1/0)	1x (10 to 1/0)	1x (10 to 1/0)	1x (10 to 1/0)	1x (8 to 1/0)	1x (8 to 1/0)	1x (6 to 1/0)	1x (6 to 1/0)	1x (4 to 1/0)

Bending Space	12" (305 mm)				16" (406 mm)							
	HP Voltage	75	100	125	150	200	250	300	350	400	450	500
208	2x (1/0 to 500)	2x (2/0 to 500)	2x (4/0 to 500)	2x (250 to 500)	3x (4/0 to 500)	-----	-----	-----	-----	-----	-----	-----
220 to 240	1x (250)	2x (2/0 to 500)	2x (3/0 to 500)	2x (4/0 to 500)	2x (350 to 500)	3x (250 to 500)	-----	-----	-----	-----	-----	-----
380 to 416	1x (1/0 to 3/0)	1x (3/0 to 250)	1x (250)	2x (1/0 to 500)	2x (3/0 to 500)	2x (4/0 to 500)	2x (300 to 500)	2x (400 to 500)	3x (250 to 500)	3x (300 to 500)	-----	-----
440 to 480	1x (1 to 3/0)	1x (2/0 to 3/0)	1x (3/0 to 250)	1x (4/0 to 250)	2x (1/0 to 500)	2x (3/0 to 500)	2x (4/0 to 500)	2x (300 to 500)	2x (350 to 500)	2x (400 to 500)	3x (250 to 500)	-----
600	1x (3 to 1/0)	1x (1 to 3/0)	1x (2/0 to 3/0)	1x (3/0 to 250)	1x (250)	2x (2/0 to 500)	2x (3/0 to 500)	2x (4/0 to 500)	2x (250 to 500)	2x (300 to 500)	2x (350 to 500)	-----
Bending Space	5" (127 mm)			8" (203 mm)				12" (305 mm)				

## Power Terminals

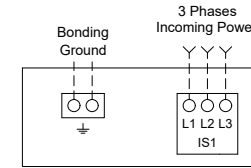

## ALUMINUM CONDUCTORS for Isolating Switch (IS1).

Field Wiring According to Bending Space (AWG or MCM). Terminals L1 - L2 - L3

Bending Space	5" (127 mm)							8" (203 mm)		10" (254 mm)
	HP Voltage	5	7.5	10	15	20	25	30	40	50
208	1x (10 to 1/0)	1x (6 to 1/0)	1x (6 to 1/0)	1x (4 to 1/0)	1x (3 to 1/0)	1x (2 to 1/0)	1x (1/0)	1x (3/0)	1x (4/0 to 250)	1x (300)** or 1x (250) 90°C *
220 to 240	1x (10 to 1/0)	1x (8 to 1/0)	1x (6 to 1/0)	1x (4 to 1/0)	1x (3 to 1/0)	1x (2 to 1/0)	1x (1 to 1/0)	1x (2/0 to 3/0)	1x (3/0) 90°C *	1x (250)
380 to 416	1x (10 to 1/0)	1x (10 to 1/0)	1x (10 to 1/0)	1x (6 to 1/0)	1x (6 to 1/0)	1x (4 to 1/0)	1x (4 to 1/0)	1x (2 to 1/0)	1x (1 to 1/0)	1x (1/0)
440 to 480	1x (10 to 1/0)	1x (10 to 1/0)	1x (10 to 1/0)	1x (8 to 1/0)	1x (6 to 1/0)	1x (6 to 1/0)	1x (6 to 1/0)	1x (4 to 1/0)	1x (2 to 1/0)	1x (1 to 1/0)
600	1x (10 to 1/0)	1x (10 to 1/0)	1x (10 to 1/0)	1x (10 to 1/0)	1x (8 to 1/0)	1x (6 to 1/0)	1x (6 to 1/0)	1x (4 to 1/0)	1x (4 to 1/0)	1x (2 to 1/0)

Bending Space	12" (305 mm)				16" (406 mm)							
	HP Voltage	75	100	125	150	200	250	300	350	400	450	500
208	2x (2/0 to 500)	2x (4/0 to 500)	2x (300 to 500)	2x (350 to 500)	3x (300 to 500)	-----	-----	-----	-----	-----	-----	-----
220 to 240	1x (350)**	2x (3/0 to 500)	2x (250 to 500)	2x (300 to 500)	2x (500)	3x (400 to 500)	-----	-----	-----	-----	-----	-----
380 to 416	N/A	1x (250 to 350)	1x (350)**	2x (3/0 to 500)	2x (4/0 to 500)	2x (300 to 500)	2x (500)	3x (300 to 500)**	3x (350 to 500)	3x (400 to 500)	-----	-----
440 to 480	1x (1/0 to 3/0)	1x (3/0)	N/A	1x (300 to 350)**	2x (3/0 to 500)	2x (250 to 500)	2x (300 to 500)	2x (400 to 500)	2x (500)	2x (500) 90°C *	3x (350 to 500)	-----
600	1x (1 to 1/0)	1x (2/0 to 3/0)	1x (3/0) 90°C *	1x (4/0 to 250)	1x (350 to 500)	2x (3/0 to 500)	2x (4/0 to 250)	2x (300 to 500)	2x (350 to 500)	2x (400 to 500)	2x (500)	-----
Bending Space	5" (127 mm)			8" (203 mm)				12" (305 mm)				

### Notes:

- 1 - For proper wire sizing, refer to NFPA70 and NEC (USA) or CEC (Canada) or local code.
- 2 - Controller suitable for service entrance in USA.
- 3 - For more accurate motor connections refer to motor manufacturer or motor nameplate.
- 4 - Controller is phase sensitive. Incoming lines must be connected in ABC sequence.

Drawing for information only.  
 Manufacturer reserves the right to modify this drawing without notice.  
 Contact manufacturer for "As Built" drawing.

\*For standard enclosure, use 90°C aluminium wire. Consult Factory for Use of Conductors Rated Lower than 90°C.

\*\* Consult Factory



© Tornatech, Inc. Not for construction.  
Subject to change without notice.

BY		DD/MM/YY
DRAWN BY	ZS	08/09/23
FINAL APPROVAL	FC	08/09/23

# ELECTRIC ADDITIVE (FOAM) PUMP CONTROLLER

**MODEL:GPA**

BUILT TO THE LATEST EDITION OF THE NFPA20 & NFPA70



DRAWING NUMBER	GPX-TD871/E
DWG REV. 0	
SHEET 1 OF 1	

## COPPER CONDUCTORS for Motor Connection (1M).

Field Wiring According to Bending Space (AWG or MCM). Terminals T1 - T2 - T3

HP Voltage	5	7.5	10	15	20	25	30	40	50	60
208	1x (10 to 2)	1x (8 to 2)	1x (8 to 2)	1x (6 to 2)	1x (4 to 2)	1x (3 to 2/0)	1x (2 to 2/0)	1x (1/0 to 3/0)	1x (3/0)	1x (4/0 to 300)
220 to 240	1x (10 to 2)	1x (10 to 2)	1x (8 to 2)	1x (6 to 2)	1x (4 to 2)	1x (4 to 2/0)	1x (3 to 2/0)	1x (1/0 to 3/0)	1x (2/0 to 3/0)	1x (3/0)
380 to 416	1x (10 to 2)	1x (10 to 2)	1x (10 to 2)	1x (8 to 2)	1x (8 to 2)	1x (6 to 2)	1x (6 to 1/0)	1x (4 to 2)	1x (3 to 2/0)	1x (1 to 2/0)
440 to 480	1x (10 to 2)	1x (10 to 2)	1x (10 to 2)	1x (10 to 2)	1x (8 to 2)	1x (8 to 2)	1x (6 to 2)	1x (6 to 2)	1x (4 to 2/0)	1x (3 to 2/0)
600	1x (10 to 2)	1x (10 to 2)	1x (10 to 2)	1x (10 to 2)	1x (10 to 2)	1x (8 to 2)	1x (8 to 2)	1x (6 to 2)	1x (6 to 2)	1x (4 to 2/0)

HP Voltage	75	100	125	150	200	250	300	350	400	450	500
208	1x (300)	2x (2/0 to 300)	2x (4/0 to 300)	2x (250 to 300)	2x (400 to 600)	-----	-----	-----	-----	-----	-----
220 to 240	1x (250 to 300)	2x (2/0 to 300)	2x (3/0 to 300)	2x (4/0 to 300)	2x (350 to 500)	2x (500 to 600)	-----	-----	-----	-----	-----
380 to 416	1x (1/0 to 3/0)	1x (3/0)	1x (250 to 300)	1x (300)	2x (3/0 to 300)	2x (4/0 to 300)	2x (300)	2x (400 to 500)	2x (500 to 600)	2x (600)	
440 to 480	1x (1 to 1/0)	1x (2/0 to 3/0)	1x (3/0)	1x (4/0 to 300)	2x (1/0 to 300)	2x (3/0 to 300)	2x (4/0 to 300)	2x (300)	2x (350 to 500)	2x (400 to 600)	2x (500 to 600)
600	1x (3 to 1/0)	1x (1 to 1/0)	1x (2/0 to 3/0)	1x (3/0)	1x (250 to 300)	2x (2/0 to 300)	2x (3/0 to 300)	2x (4/0 to 300)	2x (250 to 300)	2x (300)	2x (350 to 500)

## Motor Terminals

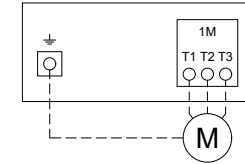

Model:GPA

## ALUMINUM CONDUCTORS for Contactor (1M).

Field Wiring According to Bending Space (AWG or MCM). Terminals T1 - T2 - T3

HP Voltage	5	7.5	10	15	20	25	30	40	50	60
208	1x (10 to 2/0) **	1x (10 to 2/0) **	1x (6 to 2/0) **	1x (4 to 2/0) **	1x (2 to 2/0) **	1x (1 to 2/0) **	1x (1/0 to 2/0) **	1x (2/0) 90°C *	Consult Factory	1x (300)
220 to 240	1x (10 to 2/0) **	1x (10 to 2/0) **	1x (8 to 2/0) **	1x (4 to 2/0) **	1x (3 to 2/0) **	1x (2 to 2/0) **	1x (1 to 2/0) **	1x (2/0)	1x (3/0) 90°C *	Consult Factory
380 to 416	1x (12 to 2/0) **	1x (12 to 2/0) **	1x (10 to 2/0) **	1x (8 to 2/0) **	1x (6 to 2/0) **	1x (6 to 2/0) **	1x (4 to 2/0) **	1x (2 to 2/0) **	1x (1 to 1/0)	1x (1/0)
440 to 480	1x (12 to 2/0) **	1x (12 to 2/0) **	1x (10 to 2/0) **	1x (10 to 2/0) **	1x (8 to 2/0) **	1x (6 to 2/0) **	1x (6 to 2/0) **	1x (4 to 2/0) **	1x (2 to 1/0)	1x (1 to 1/0)
600	1x (12 to 2/0) **	1x (12 to 2/0) **	1x (12 to 2/0) **	1x (10 to 2/0) **	1x (10 to 2/0) **	1x (8 to 2/0) **	1x (8 to 2/0) **	1x (4 to 2/0) **	1x (4 to 2/0) **	1x (2 to 1/0)

HP Voltage	75	100	125	150	200	250	300	350	400	450	500
208	1x (300) 90°C *	2x (4/0 to 300)	2x (300)	2x (300) 90°C *	2x (600)	-----	-----	-----	-----	-----	-----
220 to 240	1x (300) 90°C *	2x (3/0 to 300)	2x (250 to 300)	2x (300)	2x (500)	2x (600)	-----	-----	-----	-----	-----
380 to 416	1x (3/0)	Consult Factory	1x (300) 90°C *	Consult Factory	2x (4/0 to 300)	2x (300)	Consult Factory	2x (600)	2x (600) 90°C *	2x (600) 90°C *	-----
440 to 480	1x (1/0)	1x (3/0)	Consult Factory	1x (300)	2x (3/0 to 300)	2x (250 to 300)	2x (300)	2x (300) 90°C *	2x (500)	2x (600)	2x (600) 90°C *
600	1x (1 to 1/0)	Consult Factory	1x (3/0) 90°C *	Consult Factory	1x (300) 90°C *	2x (3/0 to 300)	2x (4/0 to 300)	2x (300)	2x (300) 90°C *	2x (300) 90°C *	Consult Factory

\* For standard enclosure, use 90°C aluminium wire. Consult Factory for Use of Conductors Rated Lower than 90°C.

\*\* Option V659 required.

### Notes:

- 1 - For proper wire sizing, refer to NFPA70 and NEC (USA) or CEC (Canada) or local code.
- 2 - Controller suitable for service entrance in USA.
- 3 - For more accurate motor connections refer to motor manufacturer or motor nameplate.
- 4 - Controller is phase sensitive. Incoming lines must be connected in ABC sequence.

Drawing for information only.  
Manufacturer reserves the right to modify this drawing without notice.  
Contact manufacturer for "As Built" drawing.



BY DD/MM/YY

DRAWN BY ZS 08/09/23

FINAL APPROVAL FC 08/09/23

# ELECTRIC ADDITIVE (FOAM) PUMP CONTROLLER

## MODEL:GPA/GPY

BUILT TO THE LATEST EDITION OF THE NFPA20 & NFPA70

© Tornatech, Inc. Not for construction.  
Subject to change without notice.



DRAWING NUMBER  
**GPX-TD873/E**  
DWG REV. 0  
SHEET 1 OF 1

### Field Connections

Terminals Wire Size:  
24 - 12 AWG  
0.5 Nm

### Alarm Contacts

Terminals Wire Size:  
24 - 12 AWG  
0.5 Nm

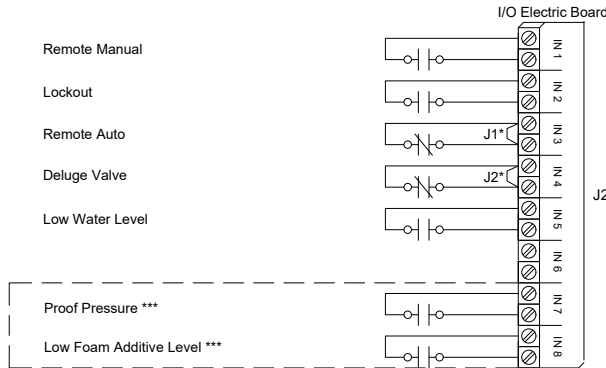

Controller Terminal Strip  
J25

Motor Run

Power Available

Normal Power Phase Reversal

Pump Room Alarm\*\*

Motor Trouble\*\*

Low Foam Additive Level\*\*\*

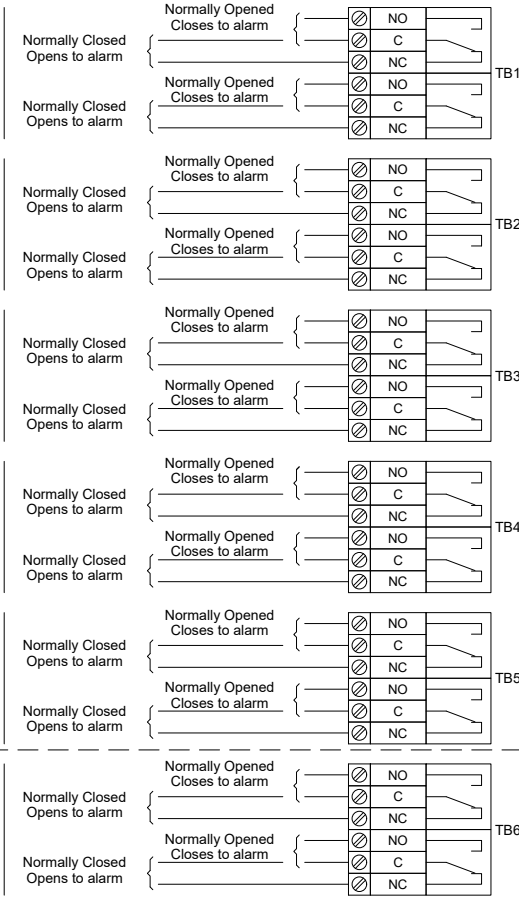

### Network Connections

Terminals Wire Size:  
Shielded Female Connector RJ45

Located on Main Board

Modbus TCP/IP RJ45



\* Remove jumper to use this feature  
\*\* Re-assignable  
\*\*\* Optional