



# TORNATECH

Project: \_\_\_\_\_

Customer: \_\_\_\_\_

Engineer: \_\_\_\_\_

Pump Manufacturer: \_\_\_\_\_

## Technical Data Submittal Document

### GPx Series

Full Service  
Electric Fire Pump Controller



#### Contents:

Data Sheets  
Dimensional Data  
Wiring Schematics  
Field Connections

**Note:** The drawings included in this package are for controllers covered under our standard offering. Actual AS BUILT drawings may differ from what is shown in this package.

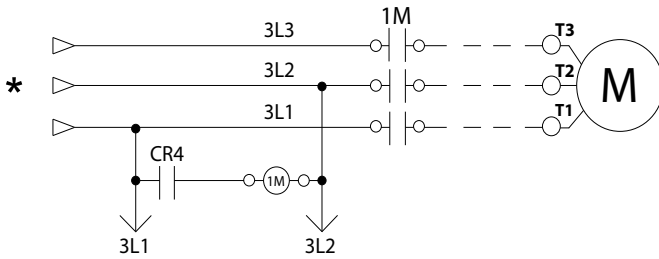
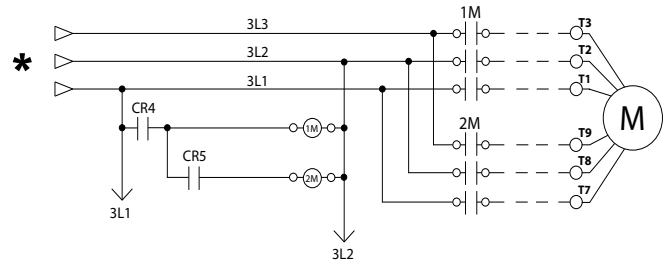
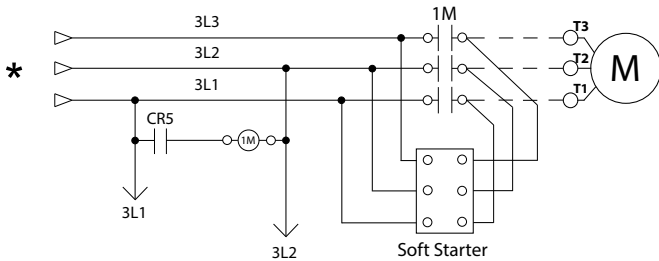
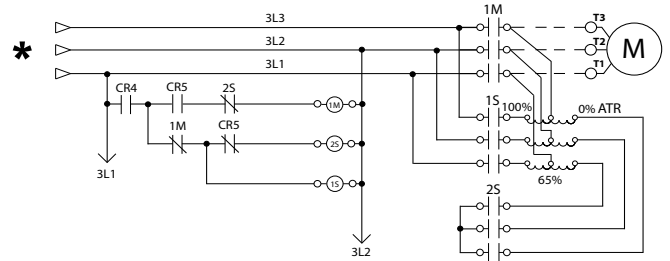
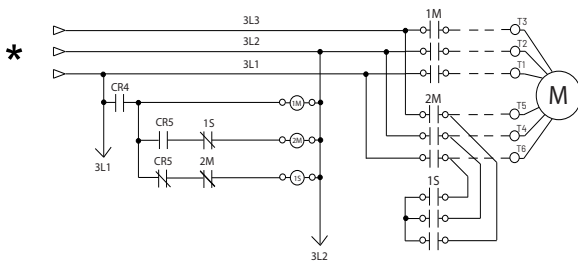
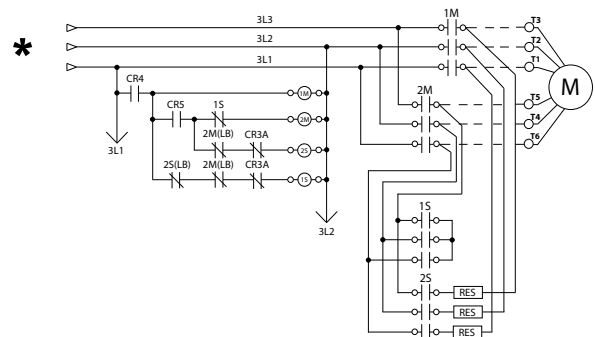

June 2022

**Select starting method**
**Model GPA**  
**Across the line**

**Model GPP**  
**Partwinding**

**Model GPS**  
**Soft Start Soft Stop**

**Model GPR**  
**Autotransformer**

**Model GPY**  
**Wye-Delta Open**

**Model GPW**  
**Wye-Delta Closed**

\*From normal incoming power through Disconnecting Means (IS/CB)





|   |  |  |      |
|---|--|--|------|
| <b>Standard, Listings, Approvals and Certifications</b> | <b>Built to NFPA 20 (latest edition)</b>   |  |      |
|   | <b>Underwriters Laboratory (UL)</b>  | UL218 - Fire Pump Controllers  |      |
|   | <b>FM Global</b>   | Class 1321/1323  |      |
|   | <b>New York City</b>   | Accepted for use in the City of New York by the Department of Buildings                      |      |
|   | <b>CE Mark</b>   | Various EN, IEC & CEE directives and standards   |      |
|   | Built in Canada or U.A.E   | Built in Europe  |      |
|   | CE Mark Option   | Supplied as Standard   |      |
| <b>Enclosure</b>  | <b>Protection Rating</b>   |  |      |
|   | Built in Canada or U.A.E   | Built in Europe  |      |
|   | Standard: NEMA 2   | Standard: IP55   |      |
|   | <b>Optional</b>  |  |      |
|   | NEMA 12  | NEMA 4X-304 sst painted  | IP54 |
|   | NEMA 3   | NEMA 4X-304 sst brushed finish   | IP55 |
|   | NEMA 3R  | NEMA 4X-316 sst painted  | IP65 |
|   | NEMA 4   | NEMA 4X-316 sst brushed finish   | IP66 |
|   | <b>Accessories</b><br>• Bottom entry gland plate<br>• Lifting Lugs<br>• Keylock handle | <b>Paint Specifications</b><br>• Red RAL3002<br>• Powder coating<br>• Glossy textured finish |      |

| Shortcircuit Withstand Rating | 200V to 208V<br>60Hz | 220V to 240V<br>60Hz | 380V to 415V<br>50 Hz / 60Hz | 440V to 480V<br>60Hz  | 575V to 600V<br>60Hz |
|-------------------------------|----------------------|----------------------|------------------------------|-----------------------|----------------------|
|                               | HP (kw)              |                      |                              |                       |                      |
| <b>Standard 100kA</b>         | 5 - 150 (3.7 - 110)  | 5 - 200 (3.7 - 149)  | 5 - 300 (3.7 - 223)          | 5 - 400 (3.7 - 298)   | N/A                  |
| <b>Optional 150kA</b>         |                      |                      |                              |                       |                      |
| <b>Standard 50kA</b>          | 200 (149)            | 250 (186)            | 350 - 450 (261-335)          | 450 - 500 (335 - 373) | 5 - 500 (3.7- 373)   |
| <b>Optional 100kA</b>         | N/A                  | N/A                  | 350 - 500 (261 - 373)        | 450 - 500 (335 - 373) |                      |
| <b>Optional 200kA</b>         | 5 - 150 (3.7 - 110)  | 5 - 200 (3.7 - 149)  | 5 - 300 (3.7 - 223)          | 5 - 400 (3.7 - 298)   | N/A                  |

\*Please see Disconnecting Means details on page 4



|                                    |   |
|------------------------------------|---|
| <b>Ambient Temperature Rating</b>  | <p><b>Standard:</b><br/>4°C to 40°C / 39°F to 104°F</p> <p><b>Optional:</b><br/>4°C to 55°C / 39°F to 131°F</p> <p>Controllers built in Dubai, UAE (Tornatech FZE) are supplied standard with 55°C rating.</p>  |
| <b>Surge Suppression</b>           | Surge arrestor rated to suppress surges above line voltage  |
| <b>Disconnecting Means</b>         | <ul style="list-style-type: none"> <li>• Isolating switch and circuit breaker assembly: <ul style="list-style-type: none"> <li>- Door interlocked in the ON position</li> <li>- Isolating switch rated not less than 115% of motor full load current</li> <li>- Circuit breaker continuous rating not less than 115% of motor full load current</li> <li>- Overcurrent sensing non-thermal type, magnetic only</li> <li>- Instantaneous trip setting of not more than 20 times the motor full load current</li> </ul> </li> <li>• Common flange mounted operating handle</li> </ul> |
| <b>Service Entrance Rating</b>     | Suitable as service entrance equipment  |
| <b>Emergency Start Handle</b>      | <ul style="list-style-type: none"> <li>• Flange mounted</li> <li>• Pull and latch activation</li> <li>• Integrated limit switch</li> <li>• Across the line start (direct on line)</li> </ul>  |
| <b>Locked Rotor Protector</b>      | <ul style="list-style-type: none"> <li>• Operate shunt trip to open circuit breaker</li> <li>• Factory set at 600% of motor full load current</li> <li>• Trip between 8 and 20 seconds</li> </ul>   |
| <b>Electrical Readings</b>         | <ul style="list-style-type: none"> <li>• Voltage phase to phase (normal power)</li> <li>• Amperage of each phase when motor is running</li> </ul>   |
| <b>Pressure Readings</b>           | <ul style="list-style-type: none"> <li>• Continuous system pressure display</li> <li>• Cut-in and Cut-out pressure settings</li> </ul>  |
| <b>Pressure and Event recorder</b> | <ul style="list-style-type: none"> <li>• Pressure readings with date stamp</li> <li>• Event recording with date stamp</li> <li>• Under regular maintained operation, events are stored in memory for the life of the controller.</li> <li>• Data viewable on operator interface display screen</li> <li>• Downloadable by USB port to external memory device</li> </ul>   |
| <b>Pressure Sensing</b>            | <ul style="list-style-type: none"> <li>• Pressure transducer and run test solenoid valve assembly for fresh water application</li> <li>• Pressure sensing line connection 1/2" Female NPT</li> <li>• Drain connection 3/8"</li> <li>• Rated for 0-500PSI working pressure (standard display at 0-300PSI)</li> <li>• Externally mounted with protective cover</li> </ul>   |



|                                    |   |  |   |
|------------------------------------|---|--|---|
| <b>Audible Alarm</b>               | 6" alarm bell - 85 dB at 10ft. (3m)   |  |   |
| <b>Visual Indications</b>          | <ul style="list-style-type: none"> <li>• Power available</li> <li>• Motor run</li> <li>• Periodic test</li> <li>• Manual start</li> </ul>   | <ul style="list-style-type: none"> <li>• Deluge valve start</li> <li>• Remote automatic start</li> <li>• Remote manual start</li> <li>• Emergency start</li> </ul> | <ul style="list-style-type: none"> <li>• Pump on demand/Automatic start</li> <li>• Pump room temperature (°F or °C)</li> <li>• Lockout</li> </ul> |
| <b>Visual &amp; Audible Alarms</b> | <p>Visual</p> <ul style="list-style-type: none"> <li>• Control voltage not healthy</li> <li>• Invalid cut-in</li> <li>• Lock rotor current</li> <li>• Loss of power</li> <li>• Low ambient temperature</li> <li>• Low water level</li> <li>• Motor trouble</li> <li>• Phase reversal (normal power)</li> </ul> <p>Visual and audible</p> <ul style="list-style-type: none"> <li>• Fail to start</li> </ul>  |  |   |
| <b>Remote Alarm Contacts</b>       | <p>DPDT-8A-250V.AC</p> <ul style="list-style-type: none"> <li>• Power available</li> <li>• Phase reversal</li> <li>• Motor run</li> <li>• Common pump room alarm (field re-assignable)**               <ul style="list-style-type: none"> <li>• Overvoltage</li> <li>• Undervoltage</li> <li>• Phase unbalance</li> <li>• Low pump room temperature</li> <li>• High Pump room temperature</li> </ul> </li> <li>• Common motor trouble (field re-assignable)**               <ul style="list-style-type: none"> <li>• Overcurrent</li> <li>• Fail to start</li> <li>• Undercurrent</li> <li>• Ground fault</li> </ul> </li> <li>• Free (field programmable)**</li> </ul> |  |   |

\*\*Tornatech reserves the right to use any of these three alarm points for special specific application requirements.



|   |   |   |  |
|---|---|---|--|
| <p><b>ViZiTouch V2<br/>Operator Interface</b></p>       | <ul style="list-style-type: none"> <li>• Embedded microcomputer with software PLC logic</li> <li>• 7.0" color touch screen (HMI technology)</li> <li>• Upgradable software</li> <li>• Multi-language</li> </ul> |   |  |
| <p><b>Communication<br/>Protocol<br/>Capability</b></p> | <ul style="list-style-type: none"> <li>• Protocol: Modbus</li> <li>• Connection type: Shielded female connector RJ45</li> <li>• Frame Format: TCP/IP</li> <li>• Addresses: See bulletin MOD-GPx</li> </ul>      |   |  |
| <p><b>Operation</b></p>                                 | <p><b>Automatic Start</b></p>   | <ul style="list-style-type: none"> <li>• Start on pressure drop</li> <li>• Remote start signal from automatic device</li> <li>• Deluge valve start</li> </ul> |  |
|   | <p><b>Manual Start</b></p>  | <ul style="list-style-type: none"> <li>• Start pushbutton</li> <li>• Run test pushbutton</li> <li>• Remote start from manual device</li> </ul>                |  |
|   | <p><b>Stopping</b></p>  | <ul style="list-style-type: none"> <li>• Manual with Stop pushbutton</li> <li>• Automatic after expiration of minimum run timer ***</li> </ul>                |  |
|   | <p><b>Timers</b></p>  | <p>Field Adjustable &amp;<br/>Visual Countdown</p>  | <ul style="list-style-type: none"> <li>• Minimum run timer ***(off delay)</li> <li>• Sequential start timer (on delay)</li> <li>• Periodic test timer</li> </ul> |
|   | <p><b>Actuation</b></p>   | <p>Visual Indication</p>  | <ul style="list-style-type: none"> <li>• Pressure</li> <li>• Non-pressure</li> </ul>   |
|   | <p><b>Mode</b></p>  |   | <ul style="list-style-type: none"> <li>• Automatic</li> <li>• Non-automatic</li> </ul>   |

\*\*\*Can only be used if approved by the AHJ



|      |  |      |  |
|------|--|------|--|
| A4   | Flow switch provision  | C19  | Emergency start alarm contact (DPDT)   |
| A8   | Foam pump application w/o pressure transducer and run test solenoid valve.   | C20  | Manual start alarm contact (DPDT)  |
| A9   | Low zone pump control function   | C21  | Deluge valve start alarm contact (DPDT)  |
| A10  | Middle zone pump control function  | C22  | Remote automatic start alarm contact (DPDT)  |
| A11  | High zone pump control function  | C23  | Remote manual start alarm contact (DPDT)   |
| A13  | Non-pressure actuated controller w/o pressure transducer and run test solenoid valve   | C24  | High pump room temperature alarm contact (DPDT)  |
| A16  | Lockout/interlock circuit from equipment installed inside the pump room  | C25  | Second set of standard alarm contacts (DPDT) (Typical for city of Los Angeles and Denver)  |
| B11  | Built in alarm panel (120V.AC supervisory power) providing indication for:<br>• Audible alarm & silence pushbutton for motor run, phase reversal, loss of phase.<br>• Pilot lights for loss of phase & supervisory power available | Cx   | Additional visual and alarm contact (Specify function) (DPDT)  |
| B11B | Built in alarm panel same as B11 but 220-240VAC supervisory power  | D1   | Low suction pressure transducer for fresh water rated at 0-300PSI with visual indication and alarm contact   |
| B19A | High motor temperature c/w thermostat relay and alarm contacts (DPDT)  | D1A  | Low suction pressure transducer for sea water rated at 0-300PSI with visual indication and alarm contact   |
| B19B | High motor temperature c/w PT100 relay and alarm contacts (DPDT)   | D5   | Pressure transducer and run test solenoid valve for fresh water rated for 0-500PSI (for factory calibration purposes only)   |
| B21  | Ground fault alarm detection c/w visual indication and alarm contact (DPDT)  | D5D  | Pressure transducer and run test solenoid valve for sea water rated for 0-500PSI   |
| C1   | Extra motor run alarm contact (DPDT)   | D10  | Omit mounting feet (when applicable)   |
| C4   | Periodic test alarm contact (DPDT)   | D13  | High withstand rating for:<br>• 200V to 208V @ 150HP max. = 150kA*<br>• 200V to 208V @ 200HP = 100kA*<br>• 220V to 240V @ 200HP max. = 150kA*<br>• 220V to 240V @ 250HP = 100kA*<br>• 380V to 415V @ 300HP max. = 150kA*<br>• 380V to 415V @ 350HP to 450HP = 100kA*<br>• 440V to 480V @ 400HP max. = 150kA*<br>• 440V to 480V @ 450HP to 500HP = 100kA*<br>• 600V @ 500HP max. = 100kA* |
| C6   | Low discharge pressure alarm contact (DPDT)  | D13A | High withstand rating for:<br>• 380V to 480V = 65kA*<br>• 600V = 25kA*   |
| C7   | Low pump room temperature alarm contact (DPDT)   | D13B | High withstand rating for:<br>• 200V to 208V @ 150HP max. = 200kA*<br>• 220V to 240V @ 200HP max. = 200kA*<br>• 380V to 415V @ 300HP max. = 200kA*<br>• 440V to 480V @ 400HP max. = 200kA*   |
| C10  | Low water reservoir level alarm contact (DPDT)   | D14  | Anti-condensation heater & thermostat  |
| C11  | High electric motor temperature alarm contact (DPDT)   | D14A | Anti-condensation heater & humidistat  |
| C12  | High electric motor vibration c/w visual indication and alarm contact (DPDT)   | D14B | Anti-condensation heater & thermostat & humidistat   |
| C14  | Pump on demand / automatic start alarm contact (DPDT)  |      |  |
| C15  | Pump fail to start alarm contact (DPDT)  |      |  |
| C16  | Control voltage healthy alarm contact (DPDT)   |      |  |
| C17  | Flow meter valve loop open c/w visual indication and alarm contact (DPDT)  |      |  |
| C18  | High water reservoir level c/w visual indication and alarm contact (DPDT)  |      |  |

\*For fire pump controller section only.

Note: Options chosen from this page are not electrically represented on the wiring schematics in this submittal package.



|      |  |
|------|--|
| D15  | Tropicalization  |
| D18  | CE Mark with factory certificate   |
| D26  | Modbus with RTU frame format and RS485 connection                                      |
| D27  | Motor heater connection (external single phase power source and heater on/off contact) |
| D27A | Motor heater connection (internal single phase power source and heater on/off contact) |
| D28  | Customized drawing set   |
| D34A | Field programmable I/O board - 5 Input / 5 output                                      |
| D43  | Seismic Certification compliant to CBC 2019, IBC 2018 rigid base/wall mounted only     |
| D44  | Special Seismic Certification compliant to OSHPD rigid base/wall mounted only          |

|     |  |
|-----|--|
| L01 | Other language and English (bilingual) |
| L02 | French                                 |
| L03 | Spanish                                |
| L04 | German                                 |
| L05 | Italian                                |
| L06 | Polish                                 |
| L07 | Romanian                               |
| L08 | Hungarian                              |
| L09 | Slovak                                 |
| L10 | Croatian                               |
| L11 | Czech                                  |
| L12 | Portuguese                             |
| L13 | Dutch                                  |
| L14 | Russian                                |
| L15 | Turkish                                |
| L16 | Swedish                                |
| L17 | Bulgarian                              |
| L18 | Thai                                   |
| L19 | Indonesian                             |
| L20 | Slovenian                              |
| L21 | Danish                                 |
| L22 | Greek                                  |
| L23 | Arabic                                 |
| L24 | Hebrew                                 |
| L25 | Chinese                                |

Additional Options:

---



---



---



---



---

Note: Options chosen from this page are not electrically represented on the wiring schematics in this submittal package.



### ViZiTouch V2 Operator Interface

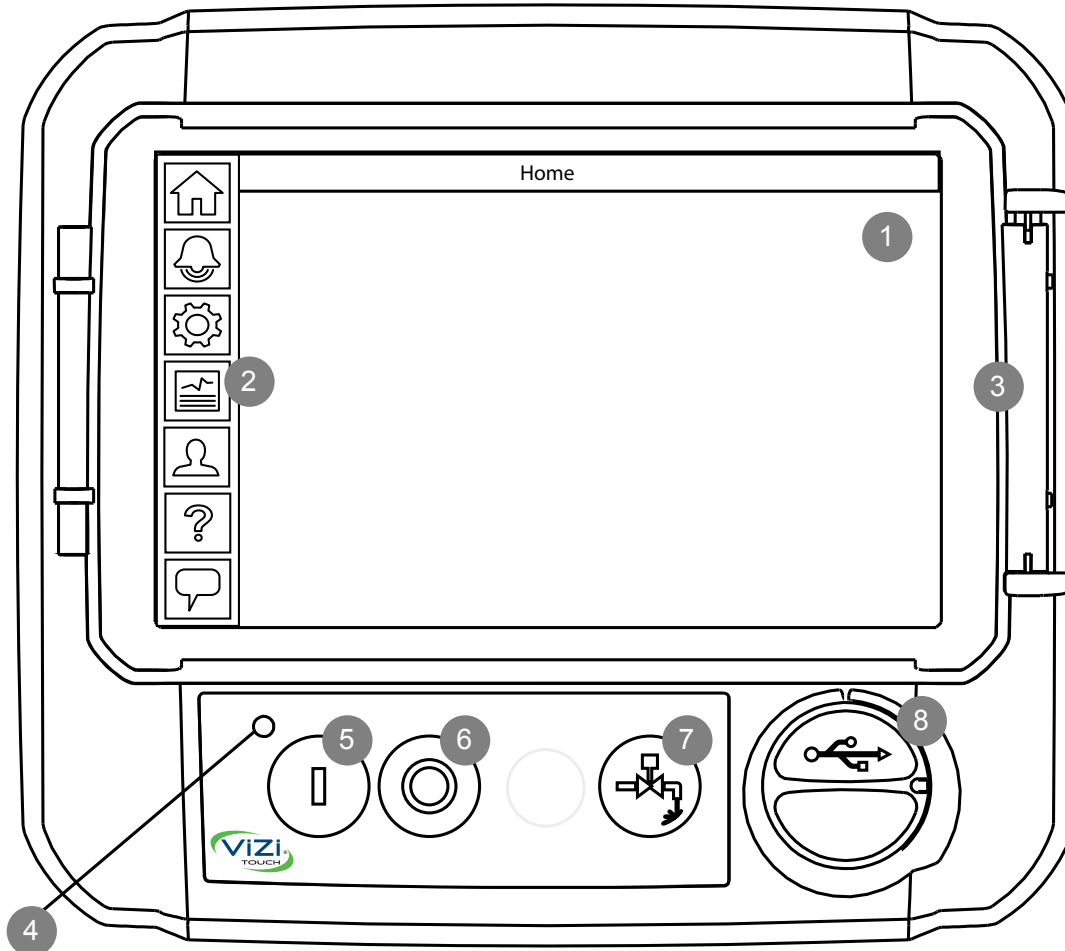

- |                        |                          |
|------------------------|--------------------------|
| 1 - Color touch screen | 3 - Screen protector     |
| 2 - Onscreen menu      | 4 - Power LED (3 colors) |
| • HOME page            | 5 - START button         |
| • ALARM page           | 6 - STOP button          |
| • CONFIGURATION page   | 7 - RUN TEST button      |
| • HISTORY page         | 8 - USB port             |
| • SERVICE page         |                          |
| • MANUAL page          |                          |
| • LANGUAGES page       |                          |

# Electric Fire Pump Controller

Model: GPA/GPY

## Dimensions

Built to the latest edition of the NFPA 20 standard

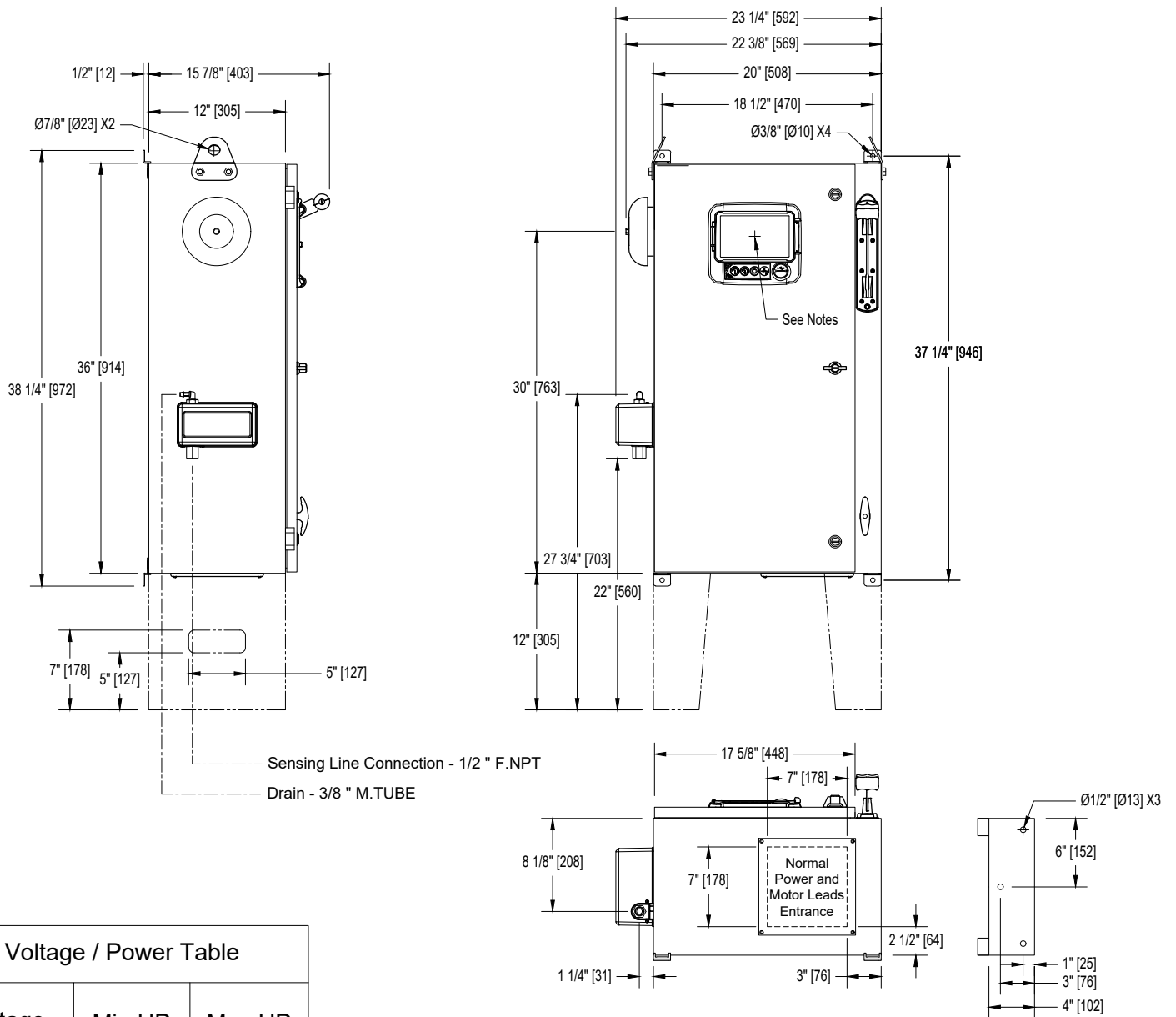

| Voltage         | Min HP | Max HP |
|-----------------|--------|--------|
| 208             | 5      | 30     |
| 220 - 240       | 5      | 30     |
| 380 - 400 - 415 | 5      | 60     |
| 440 - 480       | 5      | 60     |
| 600             | 5      | 75     |

### Notes:

- Standard NEMA: NEMA 2
- Standard paint : textured red RAL 3002.
- All dimensions are in inches [millimeters].
- Center of ViZiTouch screen: 29-5/8" [751] from bottom (no feet).
- Bottom conduit entrance through removable gland plate recommended.
- Use watertight conduit and connector only.
- Protect equipment against drilling chips.
- Door swing equal to door width.

Drawing for information only.  
 Manufacturer reserves the right to modify this drawing without notice.  
 Contact manufacturer for "As Built" drawing.

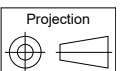

| REV. | DESCRIPTION                     | DD/MM/YY | Drawing number |
|------|---------------------------------|----------|----------------|
| 3.   | Removed Seismic logo (optional) | 18/05/22 | GPX-DI161 /E   |
| 2.   | New Logo                        | 10/05/18 |                |
| 1.   | Valve Change                    | 21/11/17 |                |

# Electric Fire Pump Controller Reduced Voltage / Part Winding

# Model: GPP

Wiring schematic

Built to the latest edition of the NFPA 20 standard

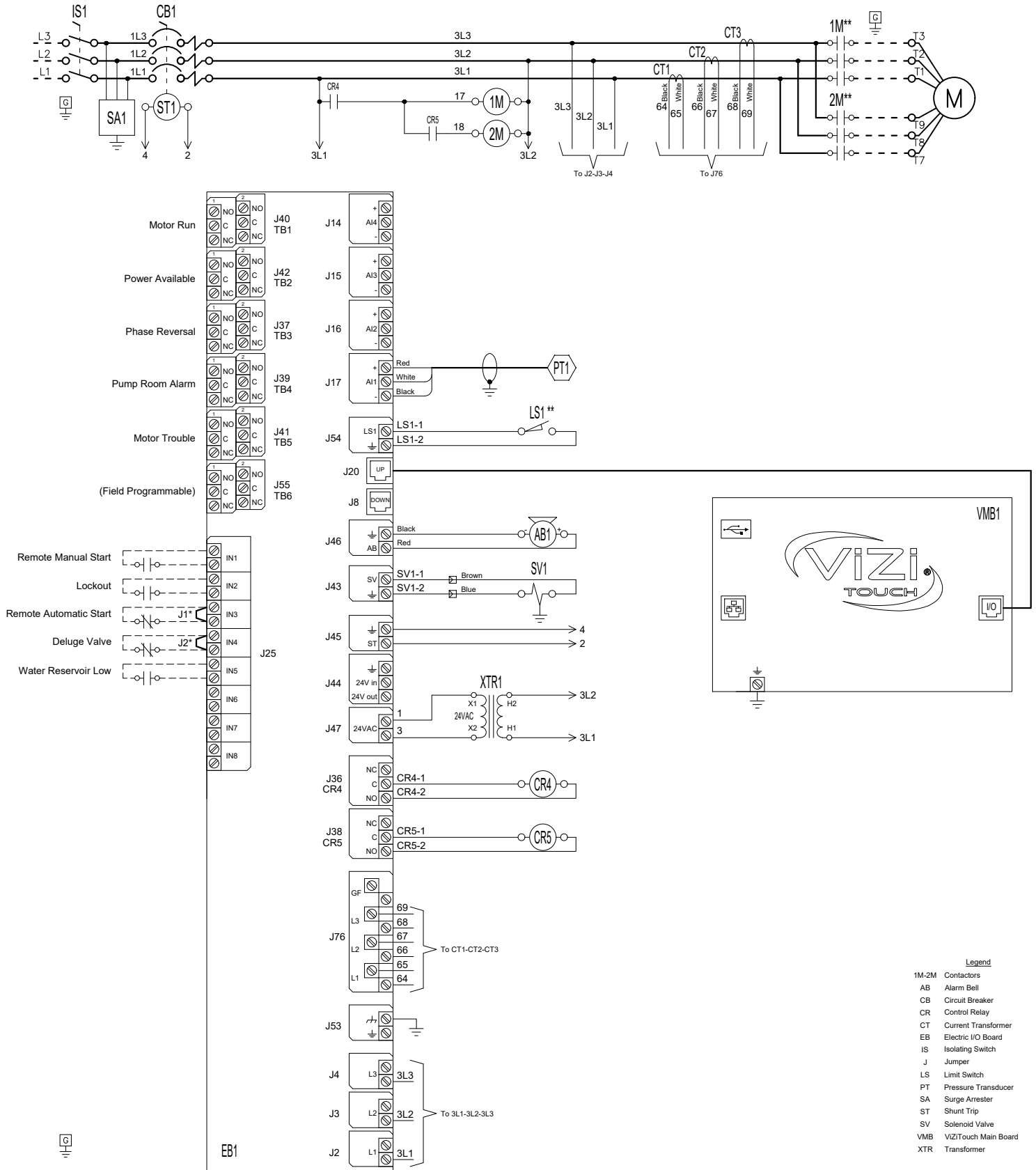

\* Remove jumper to use this feature

\*\* Contact closes when emergency start is in "ON" position

Drawing for information only.  
Manufacturer reserves the right to modify this drawing without notice.  
Contact manufacturer for "As Built" drawing.



| REV. | DESCRIPTION   | DD/MM/YY | Drawing number |
|------|---|----------|----------------|
| 3    | Removed Seismic logo (optional)                     | 18/05/22 | GPP-WS600 /E   |
| 2    | Update Logo   | 23/04/18 |                |
| 1    | Removed (fail safe) text from Power Available relay | 20/02/17 |                |

# Electric Fire Pump Controller

# Model: GPX

Terminal Diagram and Sizing for Isolating Switch

Built to the latest edition of the NFPA 20 standard

## Power Terminals

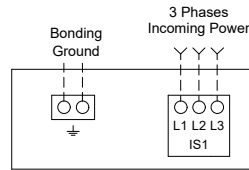

### Notes:

- 1 - For proper wire sizing, refer to NFPA70 and NEC (USA) or CEC (Canada) or local code.
- 2 - Controller suitable for service entrance in USA.
- 3 - For more accurate motor connections refer to motor manufacturer or motor nameplate.
- 4 - Controller is phase sensitive. Incoming lines must be connected in ABC sequence.

### COPPER CONDUCTORS for Isolating Switch (IS1).

Field Wiring According to Bending Space (AWG or MCM). Terminals L1 - L2 - L3

| Bending Space | 5" (127 mm)    |                |                |                |                |               |               | 8" (203 mm)     |                 |                 |
|---------------|----------------|----------------|----------------|----------------|----------------|---------------|---------------|-----------------|-----------------|-----------------|
|               | HP             | 5              | 7.5            | 10             | 15             | 20            | 25            | 30              | 40              | 50              |
| 208           | 1x (10 to 1/0) | 1x (8 to 1/0)  | 1x (8 to 1/0)  | 1x (6 to 1/0)  | 1x (4 to 1/0)  | 1x (3 to 1/0) | 1x (2 to 1/0) | 1x (1/0 to 3/0) | 1x (3/0 to 250) | 1x (4/0 to 250) |
| 220 to 240    | 1x (10 to 1/0) | 1x (10 to 1/0) | 1x (8 to 1/0)  | 1x (6 to 1/0)  | 1x (4 to 1/0)  | 1x (4 to 1/0) | 1x (3 to 1/0) | 1x (1 to 3/0)   | 1x (2/0 to 3/0) | 1x (3/0 to 250) |
| 380 to 416    | 1x (10 to 1/0) | 1x (10 to 1/0) | 1x (10 to 1/0) | 1x (8 to 1/0)  | 1x (8 to 1/0)  | 1x (6 to 1/0) | 1x (6 to 1/0) | 1x (4 to 1/0)   | 1x (3 to 1/0)   | 1x (3 to 1/0)   |
| 440 to 480    | 1x (10 to 1/0) | 1x (10 to 1/0) | 1x (10 to 1/0) | 1x (10 to 1/0) | 1x (8 to 1/0)  | 1x (8 to 1/0) | 1x (6 to 1/0) | 1x (6 to 1/0)   | 1x (4 to 1/0)   | 1x (3 to 1/0)   |
| 600           | 1x (10 to 1/0) | 1x (10 to 1/0) | 1x (10 to 1/0) | 1x (10 to 1/0) | 1x (10 to 1/0) | 1x (8 to 1/0) | 1x (8 to 1/0) | 1x (6 to 1/0)   | 1x (6 to 1/0)   | 1x (4 to 1/0)   |

| Bending Space | 12" (305 mm)    |                 |                 |                 | 16" (406 mm)    |                 |                 |                 |                 |                 |                 |          |
|---------------|-----------------|-----------------|-----------------|-----------------|-----------------|-----------------|-----------------|-----------------|-----------------|-----------------|-----------------|----------|
|               | HP              | 75              | 100             | 125             | 150             | 200             | 250             | 300             | 350             | 400             | 450             | 500      |
| 208           | 2x (1/0 to 500) | 2x (2/0 to 500) | 2x (4/0 to 500) | 2x (250 to 500) | 3x (4/0 to 500) | -----           | -----           | -----           | -----           | -----           | -----           | -----    |
| 220 to 240    | 1x (250)        | 2x (2/0 to 500) | 2x (3/0 to 500) | 2x (4/0 to 500) | 2x (350 to 500) | 3x (250 to 500) | -----           | -----           | -----           | -----           | -----           | -----    |
| 380 to 416    | 1x (1/0 to 3/0) | 1x (3/0 to 250) | 1x (250)        | 2x (1/0 to 500) | 2x (3/0 to 500) | 2x (4/0 to 500) | 2x (300 to 500) | 2x (400 to 500) | 3x (250 to 500) | 3x (300 to 500) | -----           | -----    |
| 440 to 480    | 1x (1 to 3/0)   | 1x (2/0 to 3/0) | 1x (3/0 to 250) | 1x (4/0 to 250) | 2x (1/0 to 500) | 2x (3/0 to 500) | 2x (4/0 to 500) | 2x (300 to 500) | 2x (350 to 500) | 2x (400 to 500) | 3x (250 to 500) | -----    |
| 600           | 1x (3 to 1/0)   | 1x (1 to 3/0)   | 1x (2/0 to 3/0) | 1x (3/0 to 250) | 1x (250)        | 2x (2/0 to 500) | 2x (3/0 to 500) | 2x (4/0 to 500) | 2x (250 to 500) | 2x (300 to 500) | 2x (350 to 500) | 2x (500) |

### ALUMINUM CONDUCTORS for Isolating Switch (IS1).

Field Wiring According to Bending Space (AWG or MCM). Terminals L1 - L2 - L3

| Bending Space | 5" (127 mm)    |                |                |                |               |               |               | 8" (203 mm)     |                 | 10" (254 mm)                  |
|---------------|----------------|----------------|----------------|----------------|---------------|---------------|---------------|-----------------|-----------------|-------------------------------|
|               | HP             | 5              | 7.5            | 10             | 15            | 20            | 25            | 30              | 40              | 50                            |
| 208           | 1x (10 to 1/0) | 1x (6 to 1/0)  | 1x (6 to 1/0)  | 1x (4 to 1/0)  | 1x (3 to 1/0) | 1x (1 to 1/0) | 1x (1/0)      | 1x (3/0)        | 1x (4/0 to 250) | 1x (300)** or 1x (250) 90°C * |
| 220 to 240    | 1x (10 to 1/0) | 1x (8 to 1/0)  | 1x (6 to 1/0)  | 1x (4 to 1/0)  | 1x (3 to 1/0) | 1x (2 to 1/0) | 1x (1 to 1/0) | 1x (2/0 to 3/0) | 1x (3/0) 90°C * | 1x (250)                      |
| 380 to 416    | 1x (10 to 1/0) | 1x (10 to 1/0) | 1x (10 to 1/0) | 1x (6 to 1/0)  | 1x (6 to 1/0) | 1x (4 to 1/0) | 1x (4 to 1/0) | 1x (2 to 1/0)   | 1x (1 to 1/0)   | 1x (1/0)                      |
| 440 to 480    | 1x (10 to 1/0) | 1x (10 to 1/0) | 1x (10 to 1/0) | 1x (8 to 1/0)  | 1x (6 to 1/0) | 1x (6 to 1/0) | 1x (6 to 1/0) | 1x (4 to 1/0)   | 1x (2 to 1/0)   | 1x (1 to 1/0)                 |
| 600           | 1x (10 to 1/0) | 1x (10 to 1/0) | 1x (10 to 1/0) | 1x (10 to 1/0) | 1x (8 to 1/0) | 1x (6 to 1/0) | 1x (6 to 1/0) | 1x (4 to 1/0)   | 1x (4 to 1/0)   | 1x (2 to 1/0)                 |

| Bending Space | 12" (305 mm)      |                 |                   |                                      | 16" (406 mm)    |                 |                 |                                      |                 |                 |                 |       |
|---------------|-------------------|-----------------|-------------------|--------------------------------------|-----------------|-----------------|-----------------|--------------------------------------|-----------------|-----------------|-----------------|-------|
|               | HP                | 75              | 100               | 125                                  | 150             | 200             | 250             | 300                                  | 350             | 400             | 450             | 500   |
| 208           | 2x (2/0 to 500)   | 2x (4/0 to 500) | 2x (300 to 500)   | 2x (350 to 500)                      | 3x (300 to 500) | -----           | -----           | -----                                | -----           | -----           | -----           | ----- |
| 220 to 240    | 1x (350)**<br>N/A | 2x (3/0 to 500) | 2x (250 to 500)   | 2x (300 to 500)                      | 2x (500)        | 3x (400 to 500) | -----           | -----                                | -----           | -----           | -----           | ----- |
| 380 to 416    | 1x (3/0)          | 1x (250 to 350) | 1x (350)**<br>N/A | 2x (3/0 to 500)                      | 2x (4/0 to 500) | 2x (300 to 500) | 2x (500)        | 3x (300 to 500)**<br>2x (500) 90°C * | 3x (350 to 500) | 3x (400 to 500) | -----           | ----- |
| 440 to 480    | 1x (1/0 to 3/0)   | 1x (3/0)        | 1x (250)          | 1x (300 to 350)**<br>1x (250) 90°C * | 2x (3/0 to 500) | 2x (250 to 500) | 2x (300 to 500) | 2x (400 to 500)                      | 2x (500)        | 2x (500) 90°C * | 3x (350 to 500) | ----- |
| 600           | 1x (1 to 1/0)     | 1x (2/0 to 3/0) | 1x (3/0) 90°C *   | 1x (4/0 to 250)                      | 1x (350 to 500) | 2x (3/0 to 500) | 2x (4/0 to 250) | 2x (300 to 500)                      | 2x (350 to 500) | 2x (400 to 500) | 2x (500)        | ----- |

\*For standard enclosure, use 90°C aluminium wire. Consult Factory for Use of Conductors Rated Lower than 90°C.  
\*\* Consult Factory

Drawing for information only.  
Manufacturer reserves the right to modify this drawing without notice.  
Contact manufacturer for "As Built" drawing.



| REV. | DESCRIPTION                     | DD/MM/YY | Drawing number   |
|------|---------------------------------|----------|------------------|
| 1    | Removed Seismic logo (optional) | 18/05/22 | GPX-TD612 1/2 /E |
| 0    | First issue                     | 22/12/20 |                  |

# Electric Fire Pump Controller

# Model: GPX

Terminal Diagram and Sizing For GPP, GPY & GPW

Built to the latest edition of the NFPA 20 standard

## Motor Terminals

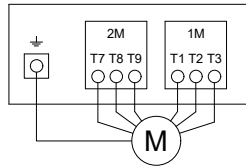

Model : GPP

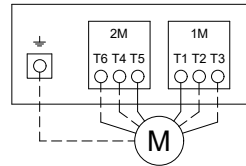

Models : GPW & GPY

### Notes:

- 1 - For proper wire sizing, refer to NFPA70 and NEC (USA) or CEC (Canada) or local code.
- 2 - Controller suitable for service entrance in USA.
- 3 - For more accurate motor connections refer to motor manufacturer or motor nameplate.
- 4 - Controller is phase sensitive. Incoming lines must be connected in ABC sequence.

### COPPER CONDUCTORS for Motor Connection (1M-2M).

Field Wiring According to Bending Space (AWG or MCM). Terminals T1-T2-T3-T4-T5-T6-T7-T8-T9

| HP<br>Voltage | 5            | 7.5          | 10           | 15           | 20           | 25           | 30           | 40            | 50            | 60            |
|---------------|--------------|--------------|--------------|--------------|--------------|--------------|--------------|---------------|---------------|---------------|
| 208           | 1x (10 to 4) | 1x (10 to 4) | 1x (10 to 4) | 1x (8 to 4)  | 1x (8 to 4)  | 1x (6 to 4)  | 1x (6 to 4)  | 1x (4 to 2/0) | 1x (2 to 2/0) | 1x (1 to 2/0) |
| 220 to 240    | 1x (10 to 4) | 1x (10 to 4) | 1x (10 to 4) | 1x (8 to 4)  | 1x (8 to 4)  | 1x (6 to 4)  | 1x (6 to 4)  | 1x (4)        | 1x (3 to 2/0) | 1x (2 to 2/0) |
| 380 to 416    | 1x (10 to 4) | 1x (10 to 4) | 1x (10 to 4) | 1x (10 to 4) | 1x (10 to 4) | 1x (10 to 4) | 1x (8 to 4)  | 1x (8 to 4)   | 1x (6 to 4)   | 1x (4)        |
| 440 to 480    | 1x (10 to 4) | 1x (10 to 4) | 1x (10 to 4) | 1x (10 to 4) | 1x (10 to 4) | 1x (10 to 4) | 1x (10 to 4) | 1x (8 to 4)   | 1x (8 to 4)   | 1x (6 to 4)   |
| 600           | 1x (10 to 4) | 1x (10 to 4) | 1x (10 to 4) | 1x (10 to 4) | 1x (10 to 4) | 1x (10 to 4) | 1x (10 to 4) | 1x (10 to 4)  | 1x (8 to 4)   | 1x (8 to 4)   |

| HP<br>Voltage | 75              | 100             | 125             | 150             | 200             | 250             | 300             | 350             | 400             | 450             | 500             |
|---------------|-----------------|-----------------|-----------------|-----------------|-----------------|-----------------|-----------------|-----------------|-----------------|-----------------|-----------------|
| 208           | 1x (2/0 to 3/0) | 1x (3/0 to 300) | 1x (250 to 300) | 2x (1/0 to 300) | 2x (3/0 to 350) | -----           | -----           | -----           | -----           | -----           | -----           |
| 220 to 240    | 1x (1/0 to 2/0) | 1x (3/0)        | 1x (4/0 to 300) | 1x (300)        | 2x (2/0 to 300) | 2x (4/0 to 350) | -----           | -----           | -----           | -----           | -----           |
| 380 to 416    | 1x (4 to 2/0)   | 1x (2 to 2/0)   | 1x (1/0 to 2/0) | 1x (2/0 to 3/0) | 1x (4/0 to 300) | 1x (300)        | 2x (2/0 to 300) | 2x (3/0 to 300) | 2x (4/0 to 350) | 2x (4/0 to 350) | -----           |
| 440 to 480    | 1x (4 to 2/0)   | 1x (3 to 2/0)   | 1x (2 to 2/0)   | 1x (1/0 to 3/0) | 1x (2/0 to 3/0) | 1x (4/0 to 300) | 1x (300)        | 2x (1/0 to 300) | 2x (2/0 to 300) | 2x (3/0 to 350) | 2x (4/0 to 350) |
| 600           | 1x (6 to 4)     | 1x (4)          | 1x (3 to 2/0)   | 1x (2 to 2/0)   | 1x (1/0 to 3/0) | 1x (2/0 to 3/0) | 1x (4/0 to 300) | 1x (250 to 300) | 1x (300)        | 2x (1/0 to 300) | 2x (2/0 to 300) |

### ALUMINUM CONDUCTORS for Contactor (1M-2M).

Field Wiring According to Bending Space (AWG or MCM). Terminals T1-T2-T3-T4-T5-T6-T7-T8-T9

| HP<br>Voltage | 5                 | 7.5               | 10                | 15                | 20                | 25                | 30                | 40               | 50               | 60               |
|---------------|-------------------|-------------------|-------------------|-------------------|-------------------|-------------------|-------------------|------------------|------------------|------------------|
| 208           | 1x (12 to 2/0) ** | 1x (10 to 2/0) ** | 1x (10 to 2/0) ** | 1x (8 to 2/0) **  | 1x (6 to 2/0) **  | 1x (4 to 2/0) **  | 1x (4 to 2/0) **  | 1x (2 to 2/0)    | 1x (1/0 to 2/0)  | 1x (2/0)         |
| 220 to 240    | 1x (12 to 2/0) ** | 1x (10 to 2/0) ** | 1x (10 to 2/0) ** | 1x (8 to 2/0) **  | 1x (8 to 2/0) **  | 1x (6 to 2/0) **  | 1x (4 to 2/0) **  | 1x (2 to 2/0) ** | 1x (1 to 2/0)    | 1x (1/0 to 2/0)  |
| 380 to 416    | 1x (12 to 2/0) ** | 1x (12 to 2/0) ** | 1x (12 to 2/0) ** | 1x (10 to 2/0) ** | 1x (10 to 2/0) ** | 1x (8 to 2/0) **  | 1x (8 to 2/0) **  | 1x (6 to 2/0) ** | 1x (4 to 2/0) ** | 1x (3 to 2/0) ** |
| 440 to 480    | 1x (12 to 2/0) ** | 1x (12 to 2/0) ** | 1x (12 to 2/0) ** | 1x (12 to 2/0) ** | 1x (10 to 2/0) ** | 1x (10 to 2/0) ** | 1x (8 to 2/0) **  | 1x (8 to 2/0) ** | 1x (6 to 2/0) ** | 1x (4 to 2/0) ** |
| 600           | 1x (12 to 2/0) ** | 1x (12 to 2/0) ** | 1x (12 to 2/0) ** | 1x (12 to 2/0) ** | 1x (10 to 2/0) ** | 1x (10 to 2/0) ** | 1x (10 to 2/0) ** | 1x (8 to 2/0) ** | 1x (8 to 2/0) ** | 1x (6 to 2/0) ** |

| HP<br>Voltage | 75               | 100              | 125             | 150             | 200             | 250             | 300             | 350             | 400             | 450             | 500             |
|---------------|------------------|------------------|-----------------|-----------------|-----------------|-----------------|-----------------|-----------------|-----------------|-----------------|-----------------|
| 208           | 1x (3/0)         | Consult Factory  | 1x (300) 90°C * | 2x (3/0 to 300) | 2x (250 to 350) | -----           | -----           | -----           | -----           | -----           | -----           |
| 220 to 240    | 1x (2/0) 90°C *  | Consult Factory  | 1x (300)        | 1x (300) 90°C * | 2x (4/0 to 300) | 2x (300 to 350) | -----           | -----           | -----           | -----           | -----           |
| 380 to 416    | 1x (2 to 2/0)    | 1x (1/0 to 2/0)  | 1x (1/0 to 2/0) | 1x (3/0) 90°C * | 1x (300)        | 1x (300) 90°C * | 2x (4/0 to 300) | 2x (250 to 300) | 2x (300 to 350) | 2x (300 to 350) | -----           |
| 440 to 480    | 1x (3 to 2/0) ** | 1x (2 to 2/0)    | 1x (2/0) 90°C * | 1x (2/0 to 3/0) | 1x (3/0) 90°C * | 1x (300)        | 1x (300) 90°C * | 2x (3/0 to 300) | 2x (4/0 to 300) | 2x (250 to 350) | 2x (300 to 350) |
| 600           | 1x (4 to 2/0) ** | 1x (3 to 2/0) ** | 1x (2 to 2/0)   | 1x (1/0 to 3/0) | 1x (3/0)        | 1x (3/0) 90°C * | 1x (300)        | 1x (300) 90°C * | Consult Factory | 2x (3/0 to 300) | 2x (4/0 to 300) |

\*For standard enclosure, use 90°C aluminium wire. Consult Factory for Use of Conductors Rated Lower than 90°C.

\*\* Option V659 required.

Drawing for information only.  
Manufacturer reserves the right to modify this drawing without notice.  
Contact manufacturer for "As Built" drawing.



| REV. | DESCRIPTION                     | DD/MM/YY | Drawing number   |
|------|---------------------------------|----------|------------------|
| 1    | Removed Seismic logo (optional) | 18/05/22 | GPX-TD612 2/2 /E |
| 0    | First issue                     | 22/12/20 |                  |

# Electric Fire Pump Controller

# Model: GPX

## Terminal Diagram and Sizing

Built to the latest edition of the NFPA 20 standard

### Control Terminals (EB1)

Terminals Wire Size:  
24 - 12 AWG  
0.5 Nm

### Remote Alarm Terminals (EB1)

Terminals Wire Size:  
24 - 12 AWG  
0.5 Nm

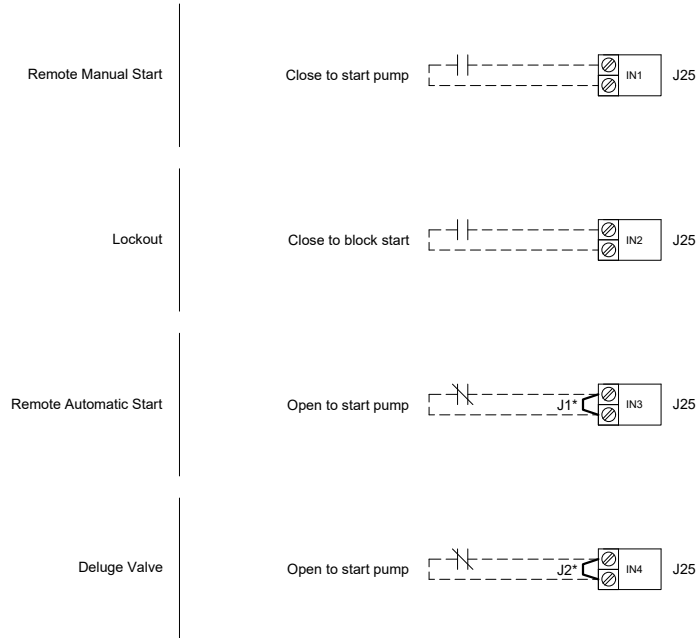

### Alarm Inputs (EB1)

Terminals Wire Size:  
24 - 12 AWG  
0.5 Nm

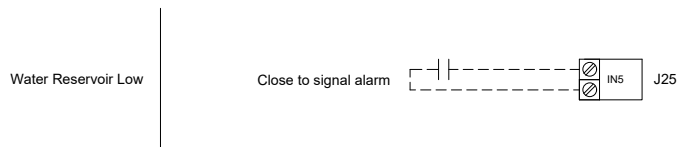

### Network Connection (VMB1)

Shielded Female Connector RJ45

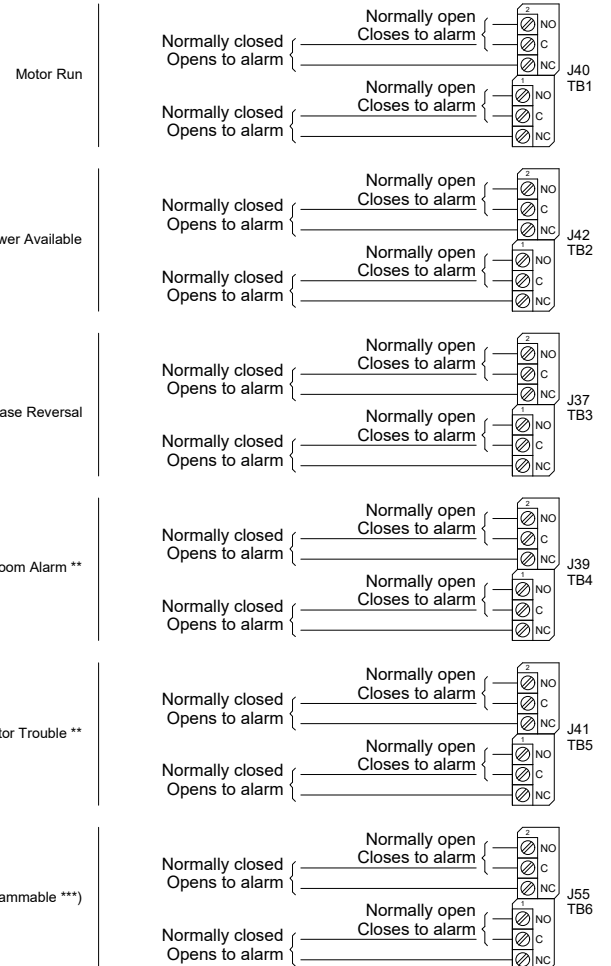
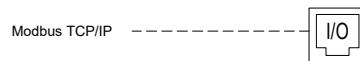

\* Remove jumper to use this feature  
\*\* Re-assignable  
\*\*\* Not available on GPS models

Drawing for information only.  
Manufacturer reserves the right to modify this drawing without notice.  
Contact manufacturer for "As Built" drawing.

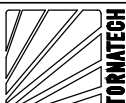

| REV. | DESCRIPTION                          | DD/MM/YY | Drawing number |
|------|--------------------------------------|----------|----------------|
| 3    | Removed Seismic logo (optional)      | 18/05/22 | GPX-TD603 / E  |
| 2    | Revised logo                         | 18/06/18 |                |
| 1    | General Revision (added AL coverage) | 10/07/17 |                |