



TORNATECH

Project: _____

Customer: _____

Engineer: _____

Pump Manufacturer: _____

Technical Data Submittal Document

GPx Series

Full Service

Electric Fire Pump Controller
with Automatic Power Transfer Switch



Contents:

Data Sheets

Dimensional Data

Wiring Schematics

Field Connections

Note: The drawings included in this package are for controllers covered under our standard offering. Actual AS BUILT drawings may differ from what is shown in this package.



March 2024

Select starting method

Model GPA Across the line

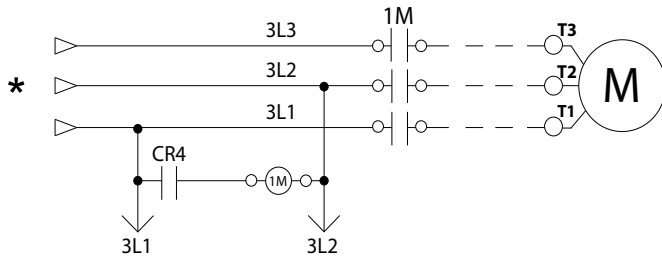

Model GPP Partwinding

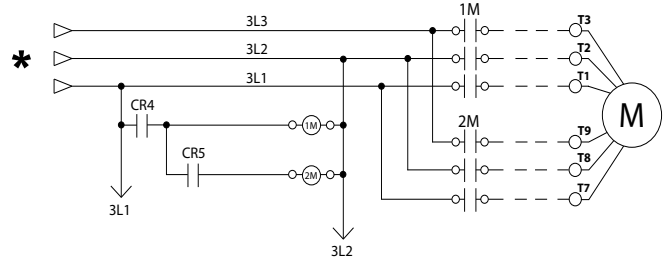

Model GPS Soft Start Soft Stop



Model GPR Autotransformer



Model GPY Wye-Delta Open

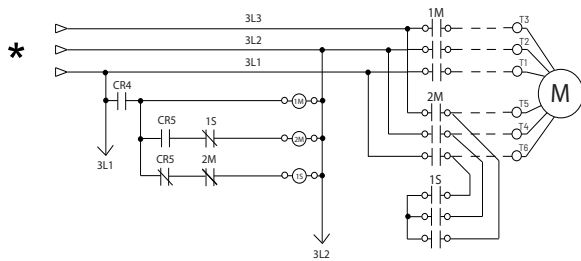

Model GPW Wye-Delta Closed

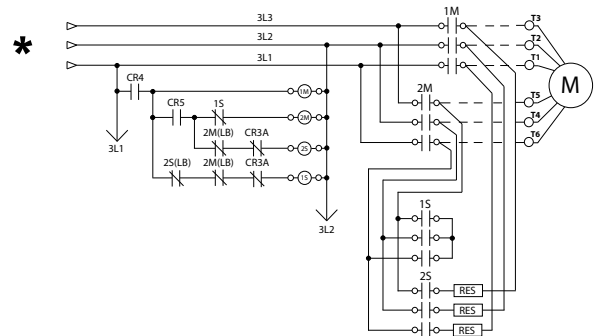

*From Automatic Power Transfer Switch



Standard, Listings, Approvals and Certifications	Built to NFPA 20 (latest edition)		
	Underwriters Laboratory (UL)	<ul style="list-style-type: none"> • UL218 - Fire Pump Controllers • UL 1008 - Automatic power transfer switches for fire pump controllers 	
	FM Global	Class 1321/1323	
	New York City	Accepted for use in the City of New York by the Department of Buildings	
	CE Mark	Various EN, IEC & CEE directives and standards	
	Built in Canada or U.A.E	Built in Europe	
	CE Mark Option	Supplied as Standard	
Enclosure	Protection Rating		
	Built in Canada or U.A.E	Built in Europe	
	Standard: NEMA 2	Standard: IP55	
	Optional		
	NEMA 12	NEMA 4X-304 sst painted	IP54
	NEMA 3	NEMA 4X-304 sst brushed finish	IP55
	NEMA 3R	NEMA 4X-316 sst painted	IP65
	NEMA 4	NEMA 4X-316 sst brushed finish	IP66
	Accessories	Paint Specifications	
	<ul style="list-style-type: none"> • Bottom entry gland plate • Lifting Lugs • Keylock handle 	<ul style="list-style-type: none"> • Red RAL3002 • Powder coating • Glossy textured finish 	

Shortcircuit Withstand Rating	200V to 208V 60Hz	220V to 240V 60Hz	380V to 415V 50 Hz / 60Hz	440V to 480V 60Hz	575V to 600V 60Hz
	HP (kw)				
Standard 100kA	5 - 150 (3.7 - 110)	5 - 200 (3.7 - 149)	5 - 300 (3.7 - 223)	5 - 400 (3.7 - 298)	N/A
Optional 150kA					
Standard 50kA	200 (149)	250 (186)	350 - 450 (261 - 335)	450 - 500 (335 - 373)	5 - 500 (3.7 - 373)
Optional 100kA	N/A	N/A	350 - 500 (261 - 373)	450 - 500 (335 - 373)	
Optional 200kA	5 - 150 (3.7 - 110)	5 - 200 (3.7 - 149)	5 - 300 (3.7 - 223)	5 - 400 (3.7 - 298)	N/A

*Please see Disconnecting Means details on page 4



Ambient Temperature Rating	<p>Standard: 4°C to 40°C / 39°F to 104°F</p> <p>Optional: 4°C to 55°C / 39°F to 131°F</p> <p>Controllers built in Dubai, UAE (Tornatech FZE) are supplied standard with 55°C rating.</p>
Surge Suppression	Surge arrestor rated to suppress surges above line voltage
Disconnecting Means	<ul style="list-style-type: none"> • Isolating switch and circuit breaker assembly: <ul style="list-style-type: none"> - Door interlocked in the ON position - Isolating switch rated not less than 115% of motor full load current - Circuit breaker continuous rating not less than 115% of motor full load current - Overcurrent sensing non-thermal type, magnetic only - Instantaneous trip setting of not more than 20 times the motor full load current • Common flange mounted operating handle
Service Entrance Rating	Suitable as service entrance equipment
Emergency Start Handle	<ul style="list-style-type: none"> • Flange mounted • Pull and latch activation • Integrated limit switch • Across the line start (direct on line)
Locked Rotor Protector	<ul style="list-style-type: none"> • Operate shunt trip to open circuit breaker • Factory set at 600% of motor full load current • Trip between 8 and 20 seconds
Electrical Readings	<ul style="list-style-type: none"> • Voltage phase to phase (normal power) • Amperage of each phase when motor is running
Pressure Readings	<ul style="list-style-type: none"> • Continuous system pressure display • Cut-in and Cut-out pressure settings
Pressure and Event recorder	<ul style="list-style-type: none"> • Pressure readings with date stamp • Event recording with date stamp • Under regular maintained operation, events are stored in memory for the life of the controller. • Data viewable on operator interface display screen • Downloadable by USB port to external memory device
Pressure Sensing	<ul style="list-style-type: none"> • Pressure transducer and run test solenoid valve assembly for fresh water application • Pressure sensing line connection 1/2" Female NPT • Drain connection 3/8" • Rated for 0-500PSI working pressure (standard display at 0-300PSI) • Externally mounted with protective cover



Audible Alarm	Alarm buzzer - 85dB at 3 meters
Visual Indications	<ul style="list-style-type: none"> • Power available • Motor run • Periodic test • Manual start • Deluge valve start • Remote automatic start • Remote manual start • Emergency start • Pump on demand/Automatic start • Pump room temperature (°F or °C) • Lockout
Visual & Audible Alarms	<p>Visual only</p> <ul style="list-style-type: none"> • Alternate lock rotor current • Alternate power phase reversal • Automatic transfer switch trouble • Control voltage not healthy • Invalid cut-in • Lock rotor current • Loss of power • Low ambient temperature • Low water level • Motor trouble • Normal power phase reversal • Overcurrent • Overvoltage • Phase loss L1 • Phase loss L2 • Phase loss L3 • Phase unbalanced • Pressure transducer fault detected • Pump on demand • Pump room alarm • Service required • Undercurrent • Undervoltage • Check weekly test solenoid • Weekly test cut-in reached <p>Visual and Audible</p> <ul style="list-style-type: none"> • ACB in OFF or tripped • Alternate IS tripped/open • Fail to start
Remote Alarm Contacts	<p>DPDT-8A-250V.AC</p> <ul style="list-style-type: none"> • Power available • Phase reversal • Motor run • Common pump room alarm (field re-assignable)** <ul style="list-style-type: none"> • Overvoltage • Undervoltage • Phase unbalance • Low pump room temperature • High Pump room temperature • Common motor trouble (field re-assignable)** <ul style="list-style-type: none"> • Overcurrent • Fail to start • Undercurrent • Ground fault • Free (field programmable)**

**Tornatech reserves the right to use any of these three alarm points for special specific application requirements.



ViZiTouch V2.1 Operator Interface	<ul style="list-style-type: none"> • Embedded microcomputer with software PLC logic • 7.0" color touch screen (HMI technology) • Upgradable software • Multi-language 			
Communication Protocol Capability	<ul style="list-style-type: none"> • Protocol: Modbus • Connection type: Shielded female connector RJ45 • Frame Format: TCP/IP • Addresses: See bulletin MOD-GPx 			
Operation	Automatic Start	<ul style="list-style-type: none"> • Start on pressure drop • Remote start signal from automatic device • Deluge valve start 		
	Manual Start	<ul style="list-style-type: none"> • Start pushbutton • Run test pushbutton • Remote start from manual device 		
	Stopping	<ul style="list-style-type: none"> • Manual with Stop pushbutton • Automatic after expiration of minimum run timer *** 		
	Timers	Field Adjustable & Visual Countdown	<ul style="list-style-type: none"> • Minimum run timer ***(off delay) • Sequential start timer (on delay) • Periodic test timer 	
	Actuation	Visual Indication	<ul style="list-style-type: none"> • Pressure • Non-pressure 	
	Mode		<ul style="list-style-type: none"> • Automatic • Non-automatic 	

***Can only be used if approved by the AHJ



Automatic Power Transfer Switch	Surge Suppression	Surge arrestor rated to suppress surges above line voltage
	Disconnecting Means	<ul style="list-style-type: none"> • Isolating switch and circuit breaker assembly: <ul style="list-style-type: none"> - Door interlocked in the ON position - Isolating switch rated not less than 115% of motor full load current - Circuit breaker continuous rating not less than 115% of motor full load current - Overcurrent sensing non-thermal type, magnetic only - Instantaneous trip setting of not more than 20 times the motor full load current • Common flange mounted operating handle
	Locked Rotor Protector	<ul style="list-style-type: none"> • Operate shunt trip to open circuit breaker • Factory set at 600% of motor full load current • Trip between 8 and 20 seconds
	Visual Indications	<ul style="list-style-type: none"> • Alternate (emergency) isolating switch in the OFF position • Alternate (emergency) voltage phase to phase • Transfer switch in normal position • Transition timers
	Visual Alarms	<ul style="list-style-type: none"> • Transfer switch trouble • Alternate power phase reversal • Alternate isolating switch open/tripped • Alternate circuit breaker open/tripped • Alternate side locked rotor current
	Transfer switch test pushbutton	
	Bypass for re-transfer and generator shutdown	
	Electrically operated and mechanically held in the normal or alternate position	
	Provision for manual operation	
	Remote Alarm Contacts SPDT-8A-250VAC <ul style="list-style-type: none"> • Isolating switch in the OFF position • Transfer switch in normal position • Transfer switch in alternate (emergency) position 	
	Time Delays <ul style="list-style-type: none"> • Momentary normal power outage override (factory set at 3 sec - field adjustable 1 to 3 sec) • Alternate (emergency) power available delay (factory set at 3 sec - field adjustable 1 to 3 sec) • Transfer trouble delay (factory set at 20 sec - field adjustable 1 to 60 sec) • Retransfer to normal (factory set at 5 min - field adjustable 1 to 20 min) • Generator cooldown (factory set at 5 min - field adjustable 1 to 20 min) 	
	Voltage Sensing <ul style="list-style-type: none"> • Transfer to alternate (normal power dropout) 85% of nominal - field adjustable 0 to 100% • Phase reversal transfer to alternate • Retransfer to normal (normal power pickup) 90% of nominal - field adjustable 0 to 100% 	
	Audible Alarm (AIS Open) Alarm buzzer - 85dB at 3 meters	
	Generator Start Connection SPDT-8A-250V.AC	



A4	Flow switch provision	C19	Emergency start alarm contact (DPDT)
A8	Foam pump application w/o pressure transducer and run test solenoid valve.	C20	Manual start alarm contact (DPDT)
A9	Low zone pump control function	C21	Deluge valve start alarm contact (DPDT)
A10	Middle zone pump control function	C22	Remote automatic start alarm contact (DPDT)
A11	High zone pump control function	C23	Remote manual start alarm contact (DPDT)
A13	Non-pressure actuated controller w/o pressure transducer and run test solenoid valve	C24	High pump room temperature alarm contact (DPDT)
A16	Lockout/interlock circuit from equipment installed inside the pump room	C25	Second set of standard alarm contacts (DPDT) (Typical for city of Los Angeles and Denver)
B11	Built in alarm panel (120V.AC supervisory power) providing indication for: • Audible alarm & silence pushbutton for motor run, phase reversal, loss of phase. • Pilot lights for loss of phase & supervisory power available	Cx	Additional visual and alarm contact (Specify function) (DPDT)
B11B	Built in alarm panel same as B11 but 220-240VAC supervisory power	D1	Low suction pressure transducer for fresh water rated at 0-300PSI with visual indication and alarm contact
B19A	High motor temperature c/w thermostat relay and alarm contacts (DPDT)	D1A	Low suction pressure transducer for sea water rated at 0-300PSI with visual indication and alarm contact
B19B	High motor temperature c/w PT100 relay and alarm contacts (DPDT)	D5	Pressure transducer and run test solenoid valve for fresh water rated for 0-500PSI (for factory calibration purposes only)
B21	Ground fault alarm detection c/w visual indication and alarm contact (DPDT)	D5D	Pressure transducer and run test solenoid valve for sea water rated for 0-500PSI
C1	Extra motor run alarm contact (DPDT)	D10	Omit mounting feet (when applicable)
C4	Periodic test alarm contact (DPDT)	D13	High withstand rating for: • 200V to 208V @ 150HP max. = 150kA* • 200V to 208V @ 200HP = 100kA* • 220V to 240V @ 200HP max. = 150kA* • 220V to 240V @ 250HP = 100kA* • 380V to 415V @ 300HP max. = 150kA* • 380V to 415V @ 350HP to 450HP = 100kA* • 440V to 480V @ 400HP max. = 150kA* • 440V to 480V @ 450HP to 500HP = 100kA* • 600V @ 500HP max. = 100kA*
C6	Low discharge pressure alarm contact (DPDT)		
C7	Low pump room temperature alarm contact (DPDT)		
C10	Low water reservoir level alarm contact (DPDT)		
C11	High electric motor temperature alarm contact (DPDT)		
C12	High electric motor vibration c/w visual indication and alarm contact (DPDT)		
C14	Pump on demand / automatic start alarm contact (DPDT)	D13A	High withstand rating for: • 380V to 480V = 65kA* • 600V = 25kA*
C15	Pump fail to start alarm contact (DPDT)	D13B	High withstand rating for: • 200V to 208V @ 150HP max. = 200kA* • 220V to 240V @ 200HP max. = 200kA* • 380V to 415V @ 300HP max. = 200kA* • 440V to 480V @ 400HP max. = 200kA*
C16	Control voltage healthy alarm contact (DPDT)		
C17	Flow meter valve loop open c/w visual indication and alarm contact (DPDT)	D14	Anti-condensation heater & thermostat
C18	High water reservoir level c/w visual indication and alarm contact (DPDT)	D14A	Anti-condensation heater & humidistat
		D14B	Anti-condensation heater & thermostat & humidistat

Note: Options chosen from this page are not electrically represented on the wiring schematics in this submittal package.



D15	Tropicalization
D18	CE Mark with factory certificate
D26	Modbus with RTU frame format and RS485 connection
D27	Motor heater connection (external single phase power source and heater on/off contact)
D27A	Motor heater connection (internal single phase power source and heater on/off contact)
D28	Customized drawing set
D34A	Field programmable I/O board - 5 Input / 5 output
D36	Redundant pressure transducer for fresh water rated for 0-500PSI
D36A	Redundant pressure transducer for sea water rated for 0-500PSI
D43	Seismic Certification compliant to CBC 2019, IBC 2018 rigid base/wall mounted only
D44	Special Seismic Certification compliant to OSHPD rigid base/wall mounted only
E1	Permanent load shedding contacts
E2	Temporary pump motor start period load shedding contacts
E3	Temporary & permanent load shedding contacts
F2	Anti condensation heater & thermostat (alternate power section)
F2A	Anti condensation heater & humidistat (alternate power section)
F2B	Anti condensation heater & thermostat & humidistat (alternate power section)
F6	High withstand rating for (model GPU only) : • 208V to 480V=150kA • 600V=100kA

L01	Other language and English (bilingual)
L02	French
L03	Spanish
L04	German
L05	Italian
L06	Polish
L07	Romanian
L08	Hungarian
L09	Slovak
L10	Croatian
L11	Czech
L12	Portuguese
L13	Dutch
L14	Russian
L15	Turkish
L16	Swedish
L17	Bulgarian
L18	Thai
L19	Indonesian
L20	Slovenian
L21	Danish
L22	Greek
L23	Arabic
L24	Hebrew
L25	Chinese

Additional Options:

Note: Options chosen from this page are not electrically represented on the wiring schematics in this submittal package.

ViZiTouch V2.1 Operator Interface



- | | |
|------------------------|---------------------------------|
| 1 - Color touch screen | 3 - Power LED (3 colors) |
| 2 - Onscreen menu | 4 - START button |
| • HOME page | 5 - STOP button |
| • ALARM page | 6 - TRANSFER SWITCH TEST button |
| • CONFIGURATION page | 7 - RUN TEST button |
| • HISTORY page | 8 - Alarm buzzer |
| • SERVICE page | |
| • MANUAL page | |
| • LANGUAGES page | |



© Tornatech, Inc. Not for construction.
Subject to change without notice.

	BY	DD/MM/YY
DRAWN BY	ACD	07/02/24
FINAL APPROVAL	FC	07/02/24

ELECTRIC FIRE PUMP CONTROLLER WITH AUTOMATIC TRANSFER SWITCH

MODEL: GPR/GPS/GPW

BUILT TO THE LATEST EDITION OF THE NFPA20 & NFPA70

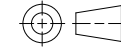

THIRD ANGLE
PROJECTION

DRAWING NUMBER	GPX-D1823 /E
DWG REV. 1	
SHEET 1 OF 1	

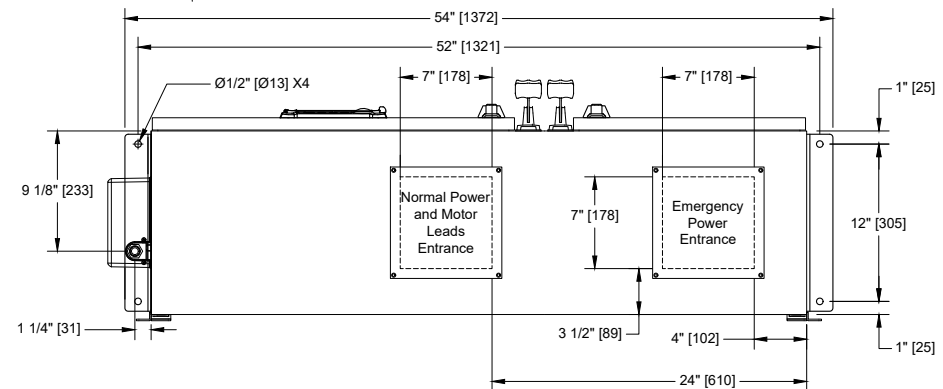
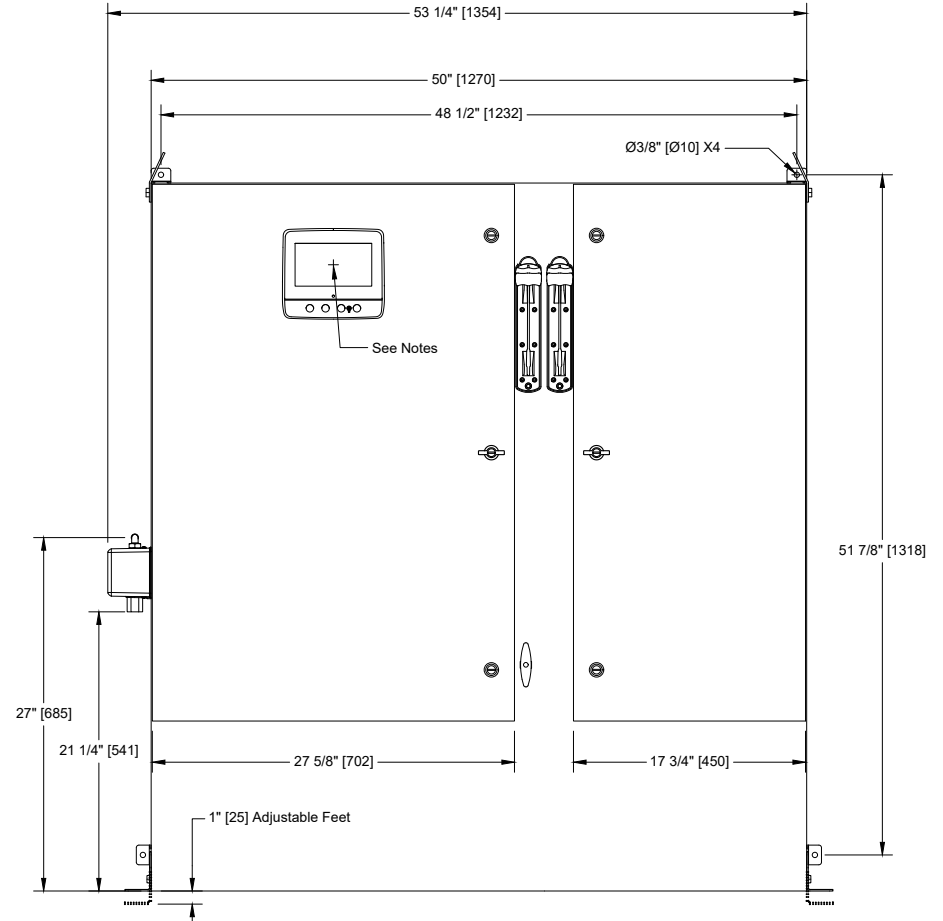
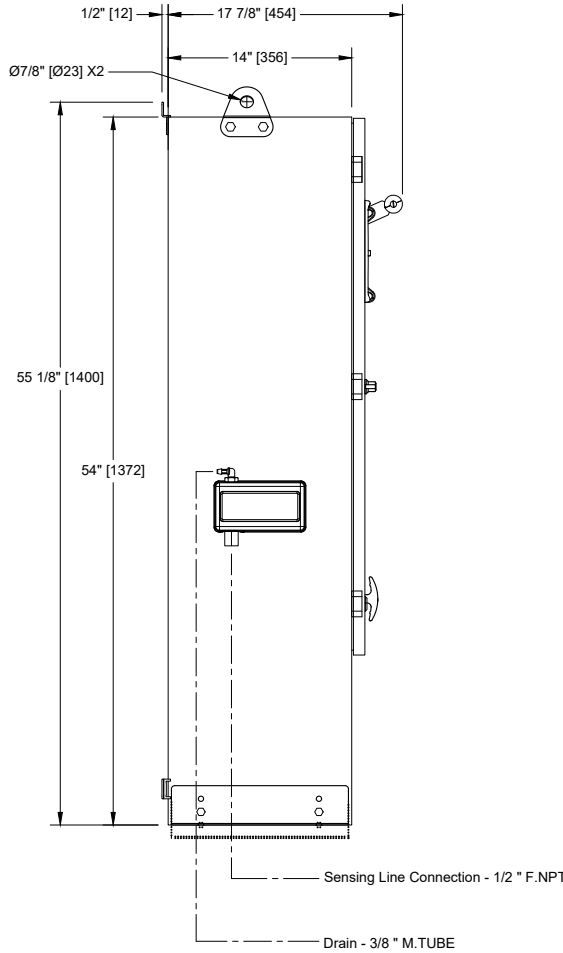

Voltage / Power Table		
Voltage	Min HP	Max HP
208	40	60
220 - 240	40	75
380 - 400 - 415	75	125
440 - 480	75	150
600	100	200

Notes:

- Standard NEMA: NEMA 2
- Standard paint : textured red RAL 3002.
- All dimensions are in inches [millimeters].
- Center of screen: 47-5/8" [1208] from bottom.
- Bottom conduit entrance through removable gland plate recommended.
- Use watertight conduit and connector only.
- Protect equipment against drilling chips.
- Door swing equal to door width.



© Tornatech, Inc. Not for construction.
Subject to change without notice.

BY DD/MM/YY	
DRAWN BY	ACD 11/01/24
FINAL APPROVAL	FC 11/01/24

ELECTRIC FIRE PUMP CONTROLLER REDUCED VOLTAGE / WYE-DELTA (CLOSED TRANSITION) WITH AUTOMATIC TRANSFER SWITCH

MODEL: GPW+GPU

BUILT TO THE LATEST EDITION OF THE NFPA20 & NFPA70



DRAWING NUMBER	GPW-WS810/E
DWG REV. 1	
SHEET 1 OF 2	

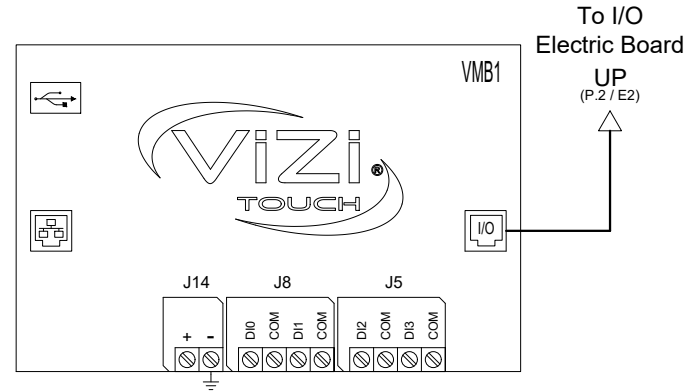
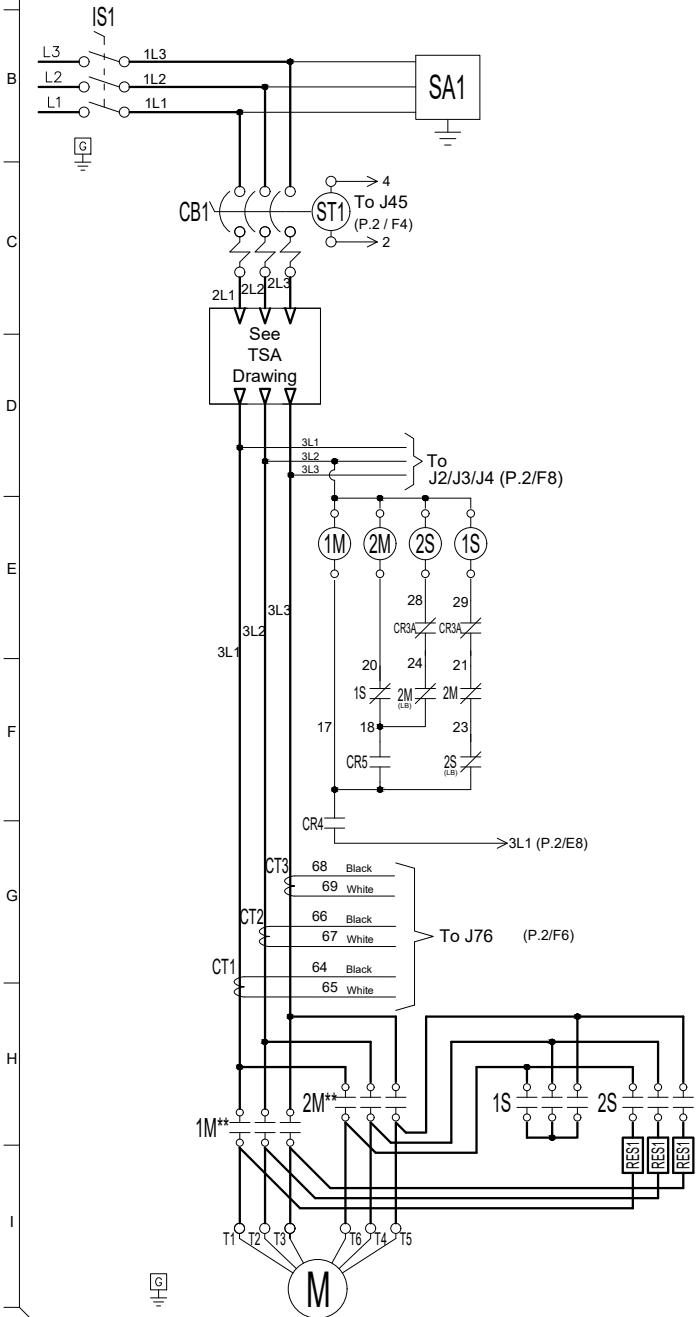

Legend	
1M-2M	Contactors
1S-2S	Contactors
AB	Alarm Bell
CB	Circuit Breaker
CR	Control Relay
CT	Current Transformer
EB	Electric I/O Board
IS	Isolating Switch
J	Jumper
LS	Limit Switch
PT	Pressure Transducer
RES	Primary Resistor
SA	Surge Arrester
ST	Shunt Trip
SV	Solenoid Valve
VMB	Main Board
XTR	Transformer



© Tornatech, Inc. Not for construction.
Subject to change without notice.

BY DD/MM/YY	
DRAWN BY	ACD 11/01/24
FINAL APPROVAL	FC 11/01/24

ELECTRIC FIRE PUMP CONTROLLER REDUCED VOLTAGE / WYE-DELTA (CLOSED TRANSITION) WITH AUTOMATIC TRANSFER SWITCH

MODEL: GPW+GPU

BUILT TO THE LATEST EDITION OF THE NFPA20 & NFPA70



DRAWING NUMBER	GPW-WS810/E
DWG REV.	1
SHEET	2 OF 2

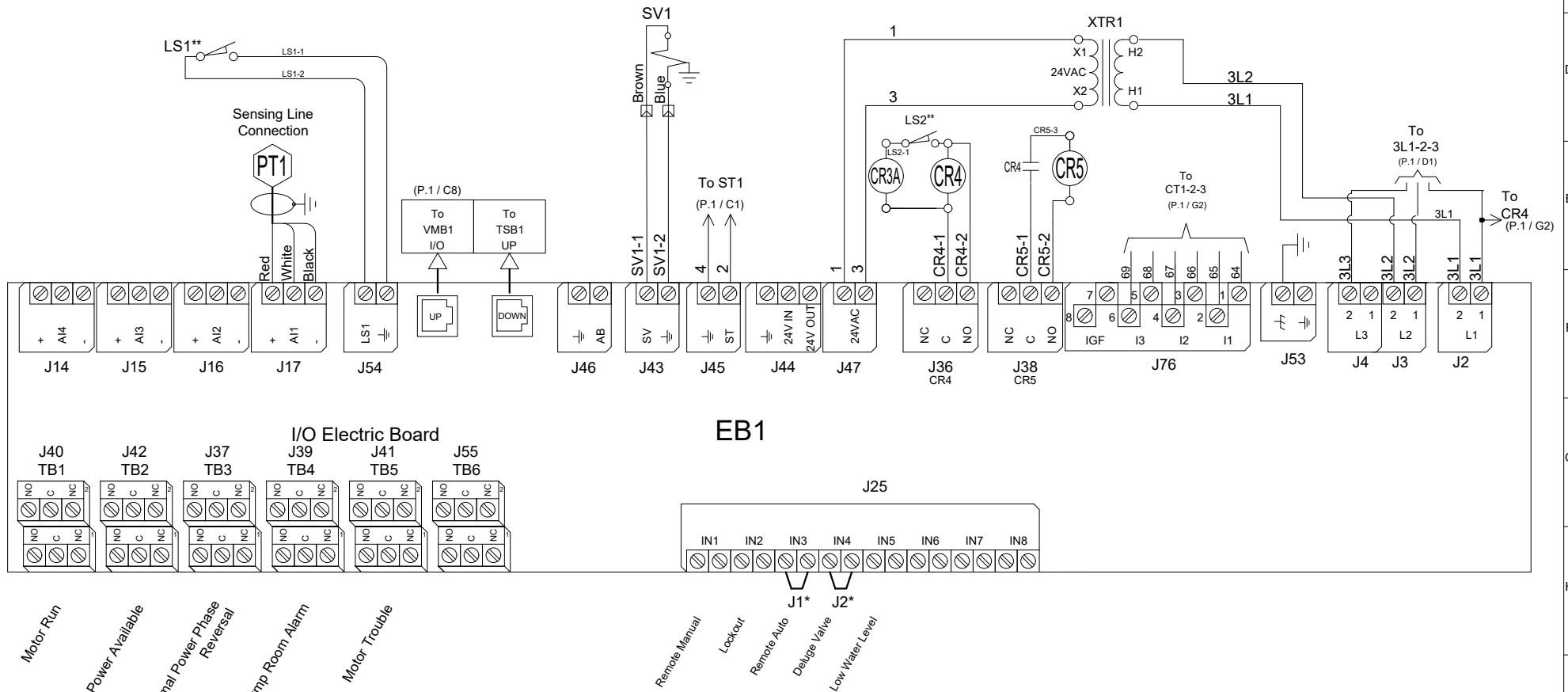

* Remove jumper to use this feature
** Contact closes when emergency start is in "ON" position



© Tornatech, Inc. Not for construction.
Subject to change without notice.

BY	DD/MM/YY
DRAWN BY	ACD 28/02/23
FINAL APPROVAL	FC 28/02/23

AUTOMATIC TRANSFER SWITCH FOR ELECTRIC FIRE PUMP CONTROLLER

MODEL: GPU

BUILT TO THE LATEST EDITION OF THE NFPA20 & NFPA70



DRAWING NUMBER	GPU-WS800/E
DWG REV. 0	
SHEET 1 OF 1	

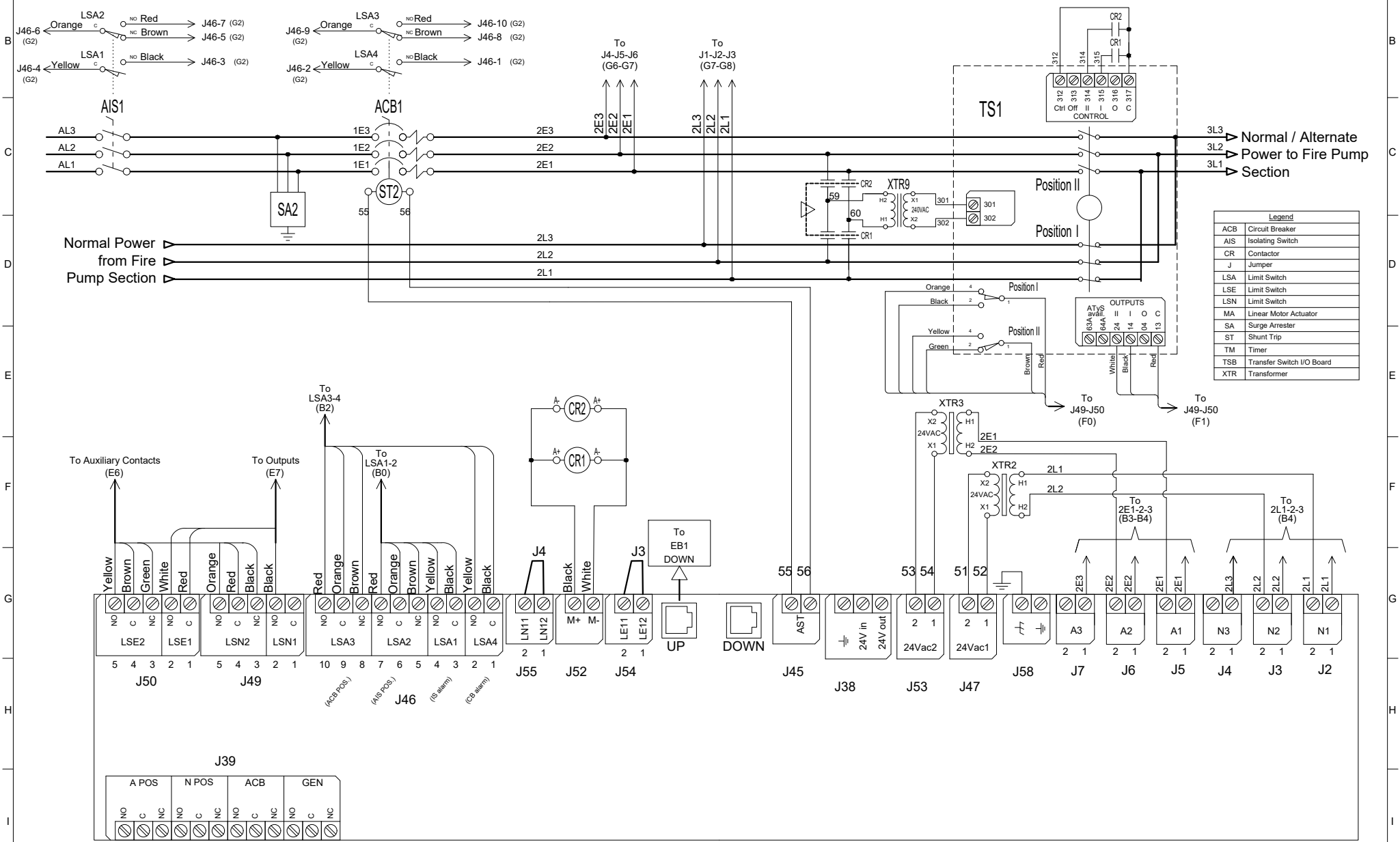

Legend	
ACB	Circuit Breaker
AIS	Isolating Switch
CR	Contactors
J	Jumper
LSA	Limit Switch
LSE	Limit Switch
LSN	Limit Switch
MA	Linear Motor Actuator
SA	Surge Arrester
ST	Shunt Trip
TM	Timer
TSB	Transfer Switch I/O Board
XTR	Transformer



© Tornatech, Inc. Not for construction.
Subject to change without notice.

BY DD/MM/YY	
DRAWN BY	ACD 28/02/23
FINAL APPROVAL	FC 28/02/23

ELECTRIC FIRE PUMP CONTROLLER

MODEL: GPX

BUILT TO THE LATEST EDITION OF THE NFPA20 & NFPA70



DRAWING NUMBER	GPX-TD800/E
DWG REV.	0
SHEET 1 OF 1	

COPPER CONDUCTORS for Isolating Switch (IS1).

Field Wiring According to Bending Space (AWG or MCM). Terminals L1 - L2 - L3

Bending Space	5" (127 mm)							8" (203 mm)		
	HP Voltage	5	7.5	10	15	20	25	30	40	50
208	1x (10 to 1/0)	1x (8 to 1/0)	1x (8 to 1/0)	1x (6 to 1/0)	1x (4 to 1/0)	1x (3 to 1/0)	1x (2 to 1/0)	1x (1/0 to 3/0)	1x (3/0 to 250)	1x (4/0 to 250)
220 to 240	1x (10 to 1/0)	1x (10 to 1/0)	1x (8 to 1/0)	1x (6 to 1/0)	1x (4 to 1/0)	1x (4 to 1/0)	1x (3 to 1/0)	1x (1 to 3/0)	1x (2/0 to 3/0)	1x (3/0 to 250)
380 to 416	1x (10 to 1/0)	1x (10 to 1/0)	1x (10 to 1/0)	1x (8 to 1/0)	1x (8 to 1/0)	1x (6 to 1/0)	1x (6 to 1/0)	1x (4 to 1/0)	1x (3 to 1/0)	1x (3 to 1/0)
440 to 480	1x (10 to 1/0)	1x (10 to 1/0)	1x (10 to 1/0)	1x (10 to 1/0)	1x (8 to 1/0)	1x (8 to 1/0)	1x (6 to 1/0)	1x (6 to 1/0)	1x (4 to 1/0)	1x (3 to 1/0)
600	1x (10 to 1/0)	1x (10 to 1/0)	1x (10 to 1/0)	1x (10 to 1/0)	1x (10 to 1/0)	1x (8 to 1/0)	1x (8 to 1/0)	1x (6 to 1/0)	1x (6 to 1/0)	1x (4 to 1/0)

Bending Space	12" (305 mm)				16" (406 mm)							
	HP Voltage	75	100	125	150	200	250	300	350	400	450	500
208	2x (1/0 to 500)	2x (2/0 to 500)	2x (4/0 to 500)	2x (250 to 500)	3x (4/0 to 500)	-----	-----	-----	-----	-----	-----	-----
220 to 240	1x (250)	2x (2/0 to 500)	2x (3/0 to 500)	2x (4/0 to 500)	2x (350 to 500)	3x (250 to 500)	-----	-----	-----	-----	-----	-----
380 to 416	1x (1/0 to 3/0)	1x (3/0 to 250)	1x (250)	2x (1/0 to 500)	2x (3/0 to 500)	2x (4/0 to 500)	2x (300 to 500)	2x (400 to 500)	3x (250 to 500)	3x (300 to 500)	-----	-----
440 to 480	1x (1 to 3/0)	1x (2/0 to 3/0)	1x (3/0 to 250)	1x (4/0 to 250)	2x (1/0 to 500)	2x (3/0 to 500)	2x (4/0 to 500)	2x (300 to 500)	2x (350 to 500)	2x (400 to 500)	3x (250 to 500)	-----
600	1x (3 to 1/0)	1x (1 to 3/0)	1x (2/0 to 3/0)	1x (3/0 to 250)	1x (250)	2x (2/0 to 500)	2x (3/0 to 500)	2x (4/0 to 500)	2x (250 to 500)	2x (300 to 500)	2x (350 to 500)	-----
Bending Space	5" (127 mm)	8" (203 mm)				12" (305 mm)						

Power Terminals

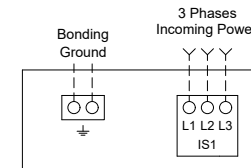

ALUMINUM CONDUCTORS for Isolating Switch (IS1).

Field Wiring According to Bending Space (AWG or MCM). Terminals L1 - L2 - L3

Bending Space	5" (127 mm)							8" (203 mm)		10" (254 mm)
	HP Voltage	5	7.5	10	15	20	25	30	40	50
208	1x (10 to 1/0)	1x (6 to 1/0)	1x (6 to 1/0)	1x (4 to 1/0)	1x (3 to 1/0)	1x (2 to 1/0)	1x (1/0)	1x (3/0)	1x (4/0 to 250)	1x (300)** or 1x (250) 90°C *
220 to 240	1x (10 to 1/0)	1x (8 to 1/0)	1x (6 to 1/0)	1x (4 to 1/0)	1x (3 to 1/0)	1x (2 to 1/0)	1x (1 to 1/0)	1x (2/0 to 3/0)	1x (3/0) 90°C *	1x (250)
380 to 416	1x (10 to 1/0)	1x (10 to 1/0)	1x (10 to 1/0)	1x (6 to 1/0)	1x (6 to 1/0)	1x (4 to 1/0)	1x (4 to 1/0)	1x (2 to 1/0)	1x (1 to 1/0)	1x (1/0)
440 to 480	1x (10 to 1/0)	1x (10 to 1/0)	1x (10 to 1/0)	1x (8 to 1/0)	1x (6 to 1/0)	1x (6 to 1/0)	1x (6 to 1/0)	1x (4 to 1/0)	1x (2 to 1/0)	1x (1 to 1/0)
600	1x (10 to 1/0)	1x (10 to 1/0)	1x (10 to 1/0)	1x (10 to 1/0)	1x (8 to 1/0)	1x (6 to 1/0)	1x (6 to 1/0)	1x (4 to 1/0)	1x (4 to 1/0)	1x (2 to 1/0)

Bending Space	12" (305 mm)				16" (406 mm)							
	HP Voltage	75	100	125	150	200	250	300	350	400	450	500
208	2x (2/0 to 500)	2x (4/0 to 500)	2x (300 to 500)	2x (350 to 500)	3x (300 to 500)	-----	-----	-----	-----	-----	-----	-----
220 to 240	1x (350)**	2x (3/0 to 500)	2x (250 to 500)	2x (300 to 500)	2x (500)	3x (400 to 500)	-----	-----	-----	-----	-----	-----
380 to 416	N/A	1x (250 to 350)	1x (350)**	2x (3/0 to 500)	2x (4/0 to 500)	2x (300 to 500)	2x (500)	3x (300 to 500)**	3x (350 to 500)	3x (400 to 500)	-----	-----
440 to 480	1x (1/0 to 3/0)	1x (3/0)	N/A	1x (300 to 350)**	2x (3/0 to 500)	2x (250 to 500)	2x (300 to 500)	2x (400 to 500)	2x (500)	2x (500) 90°C *	3x (350 to 500)	-----
600	1x (1 to 1/0)	1x (2/0 to 3/0)	1x (3/0) 90°C *	1x (4/0 to 250)	1x (350 to 500)	2x (3/0 to 500)	2x (4/0 to 250)	2x (300 to 500)	2x (350 to 500)	2x (400 to 500)	2x (500)	-----
Bending Space	5" (127 mm)	8" (203 mm)				12" (305 mm)						

Notes:

- 1 - For proper wire sizing, refer to NFPA70 and NEC (USA) or CEC (Canada) or local code.
- 2 - Controller suitable for service entrance in USA.
- 3 - For more accurate motor connections refer to motor manufacturer or motor nameplate.
- 4 - Controller is phase sensitive. Incoming lines must be connected in ABC sequence.

Drawing for information only.
Manufacturer reserves the right to modify this drawing without notice.
Contact manufacturer for "As Built" drawing.

*For standard enclosure, use 90°C aluminium wire. Consult Factory for Use of Conductors Rated Lower than 90°C.

** Consult Factory



© Tornatech, Inc. Not for construction.
Subject to change without notice.

BY DD/MM/YY	
DRAWN BY	ACD 28/02/23
FINAL APPROVAL	FC 28/02/23

AUTOMATIC TRANSFER SWITCH FOR ELECTRIC FIRE PUMP CONTROLLER

MODEL: GPU

BUILT TO THE LATEST EDITION OF THE NFPA20 & NFPA70



DRAWING NUMBER	GPU-TD800/E
DWG REV. 0	
SHEET 1 OF 1	

COPPER CONDUCTORS for Isolating Switch (AIS1).

Field Wiring According to Bending Space (AWG or MCM). Terminals AL1 - AL2 - AL3

Bending Space	5" (127 mm)							8" (203 mm)		
	HP Voltage	5	7.5	10	15	20	25	30	40	50
208	1x (10 to 1/0)	1x (8 to 1/0)	1x (8 to 1/0)	1x (6 to 1/0)	1x (4 to 1/0)	1x (3 to 1/0)	1x (2 to 1/0)	1x (1/0 to 3/0)	1x (3/0 to 250)	1x (4/0 to 250)
220 to 240	1x (10 to 1/0)	1x (10 to 1/0)	1x (8 to 1/0)	1x (6 to 1/0)	1x (4 to 1/0)	1x (4 to 1/0)	1x (3 to 1/0)	1x (1 to 3/0)	1x (2/0 to 3/0)	1x (3/0 to 250)
380 to 416	1x (10 to 1/0)	1x (10 to 1/0)	1x (10 to 1/0)	1x (8 to 1/0)	1x (8 to 1/0)	1x (6 to 1/0)	1x (6 to 1/0)	1x (4 to 1/0)	1x (3 to 1/0)	1x (3 to 1/0)
440 to 480	1x (10 to 1/0)	1x (10 to 1/0)	1x (10 to 1/0)	1x (10 to 1/0)	1x (8 to 1/0)	1x (8 to 1/0)	1x (6 to 1/0)	1x (6 to 1/0)	1x (4 to 1/0)	1x (3 to 1/0)
600	1x (10 to 1/0)	1x (10 to 1/0)	1x (10 to 1/0)	1x (10 to 1/0)	1x (10 to 1/0)	1x (8 to 1/0)	1x (8 to 1/0)	1x (6 to 1/0)	1x (6 to 1/0)	1x (4 to 1/0)

Power Terminals

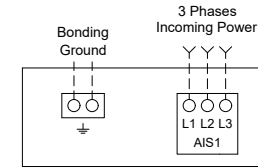

Bending Space	12" (305 mm)				16" (406 mm)							
	HP Voltage	75	100	125	150	200	250	300	350	400	450	500
208	2x (1/0 to 500)	2x (2/0 to 500)	2x (4/0 to 500)	2x (250 to 500)	3x (4/0 to 500)	-----	-----	-----	-----	-----	-----	-----
220 to 240	1x (250)	2x (2/0 to 500)	2x (3/0 to 500)	2x (4/0 to 500)	2x (350 to 500)	3x (250 to 500)	-----	-----	-----	-----	-----	-----
380 to 416	1x (1/0 to 3/0)	1x (3/0 to 250)	1x (250)	2x (1/0 to 500)	2x (3/0 to 500)	2x (4/0 to 500)	2x (300 to 500)	2x (400 to 500)	3x (250 to 500)	3x (300 to 500)	-----	-----
440 to 480	1x (1 to 3/0)	1x (2/0 to 3/0)	1x (3/0 to 250)	1x (4/0 to 250)	2x (1/0 to 500)	2x (3/0 to 500)	2x (4/0 to 500)	2x (300 to 500)	2x (350 to 500)	2x (400 to 500)	3x (250 to 500)	-----
600	1x (3 to 1/0)	1x (1 to 3/0)	1x (2/0 to 3/0)	1x (3/0 to 250)	1x (250)	2x (2/0 to 500)	2x (3/0 to 500)	2x (4/0 to 500)	2x (250 to 500)	2x (300 to 500)	2x (350 to 500)	-----
Bending Space	5" (127 mm)	8" (203 mm)				12" (305 mm)						

ALUMINUM CONDUCTORS for Isolating Switch (AIS1).

Field Wiring According to Bending Space (AWG or MCM). Terminals AL1 - AL2 - AL3

Bending Space	5" (127 mm)							8" (203 mm)		10" (254 mm)
	HP Voltage	5	7.5	10	15	20	25	30	40	50
208	1x (10 to 1/0)	1x (6 to 1/0)	1x (6 to 1/0)	1x (4 to 1/0)	1x (3 to 1/0)	1x (1 to 1/0)	1x (1/0)	1x (3/0)	1x (4/0 to 250)	1x (300)** or 1x (250) 90°C *
220 to 240	1x (10 to 1/0)	1x (8 to 1/0)	1x (6 to 1/0)	1x (4 to 1/0)	1x (3 to 1/0)	1x (2 to 1/0)	1x (1 to 1/0)	1x (2/0 to 3/0)	1x (3/0) 90°C *	1x (250)
380 to 416	1x (10 to 1/0)	1x (10 to 1/0)	1x (10 to 1/0)	1x (6 to 1/0)	1x (6 to 1/0)	1x (4 to 1/0)	1x (4 to 1/0)	1x (2 to 1/0)	1x (1 to 1/0)	1x (1/0)
440 to 480	1x (10 to 1/0)	1x (10 to 1/0)	1x (10 to 1/0)	1x (8 to 1/0)	1x (6 to 1/0)	1x (6 to 1/0)	1x (6 to 1/0)	1x (4 to 1/0)	1x (2 to 1/0)	1x (1 to 1/0)
600	1x (10 to 1/0)	1x (10 to 1/0)	1x (10 to 1/0)	1x (10 to 1/0)	1x (8 to 1/0)	1x (6 to 1/0)	1x (6 to 1/0)	1x (4 to 1/0)	1x (4 to 1/0)	1x (2 to 1/0)

Bending Space	12" (305 mm)				16" (406 mm)							
	HP Voltage	75	100	125	150	200	250	300	350	400	450	500
208	2x (2/0 to 500)	2x (4/0 to 500)	2x (300 to 500)	2x (350 to 500)	3x (300 to 500)	-----	-----	-----	-----	-----	-----	-----
220 to 240	1x (350)**	2x (3/0 to 500)	2x (250 to 500)	2x (300 to 500)	2x (500)	3x (400 to 500)	-----	-----	-----	-----	-----	-----
380 to 416	N/A	1x (250 to 350)	1x (350)**	2x (3/0 to 500)	2x (4/0 to 500)	2x (300 to 500)	2x (500)	3x (300 to 500)**	3x (350 to 500)	3x (400 to 500)	-----	-----
440 to 480	1x (1/0 to 3/0)	1x (3/0)	N/A	1x (300 to 350)**	2x (3/0 to 500)	2x (250 to 500)	2x (300 to 500)	2x (400 to 500)	2x (500)	2x (500) 90°C *	3x (350 to 500)	-----
600	1x (1 to 1/0)	1x (2/0 to 3/0)	1x (3/0) 90°C *	1x (4/0 to 250)	1x (350 to 500)	2x (3/0 to 500)	2x (4/0 to 250)	2x (300 to 500)	2x (350 to 500)	2x (400 to 500)	2x (500)	-----
Bending Space	5" (127 mm)	8" (203 mm)				12" (305 mm)						

Notes:
1 - Controller is phase sensitive. Incoming lines must be connected in ABC sequence.

Drawing for information only.
Manufacturer reserves the right to modify this drawing without notice.
Contact manufacturer for "As Built" drawing.

*For standard enclosure, use 90°C aluminium wire. Consult Factory for Use of Conductors Rated Lower than 90°C.

** Consult Factory



© Tornatech, Inc. Not for construction.
Subject to change without notice.

BY DD/MM/YY	
DRAWN BY	ACD 28/02/23
FINAL APPROVAL	FC 28/02/23

ELECTRIC FIRE PUMP CONTROLLER

MODEL: GPP/GPW/GPY

BUILT TO THE LATEST EDITION OF THE NFPA20 & NFPA70



DRAWING NUMBER	GPX-TD802/E
DWG REV. 0	
SHEET 1 OF 1	

COPPER CONDUCTORS for Motor Connection (1M-2M).

Field Wiring According to Bending Space (AWG or MCM). Terminals T1-T2-T3-T4-T5-T6-T7-T8-T9

HP Voltage	5	7.5	10	15	20	25	30	40	50	60
208	1x (10 to 4)	1x (10 to 4)	1x (10 to 4)	1x (8 to 4)	1x (8 to 4)	1x (6 to 4)	1x (6 to 4)	1x (4 to 2/0)	1x (2 to 2/0)	1x (1 to 2/0)
220 to 240	1x (10 to 4)	1x (10 to 4)	1x (10 to 4)	1x (8 to 4)	1x (8 to 4)	1x (6 to 4)	1x (6 to 4)	1x (4)	1x (3 to 2/0)	1x (2 to 2/0)
380 to 416	1x (10 to 4)	1x (10 to 4)	1x (10 to 4)	1x (10 to 4)	1x (10 to 4)	1x (10 to 4)	1x (8 to 4)	1x (8 to 4)	1x (6 to 4)	1x (4)
440 to 480	1x (10 to 4)	1x (10 to 4)	1x (10 to 4)	1x (10 to 4)	1x (10 to 4)	1x (10 to 4)	1x (10 to 4)	1x (8 to 4)	1x (8 to 4)	1x (6 to 4)
600	1x (10 to 4)	1x (10 to 4)	1x (10 to 4)	1x (10 to 4)	1x (10 to 4)	1x (10 to 4)	1x (10 to 4)	1x (10 to 4)	1x (8 to 4)	1x (8 to 4)

HP Voltage	75	100	125	150	200	250	300	350	400	450	500
208	1x (2/0 to 3/0)	1x (3/0 to 300)	1x (250 to 300)	2x (1/0 to 300)	2x (3/0 to 350)	-----	-----	-----	-----	-----	-----
220 to 240	1x (1/0 to 2/0)	1x (3/0)	1x (4/0 to 300)	1x (300)	2x (2/0 to 300)	2x (4/0 to 350)	-----	-----	-----	-----	-----
380 to 416	1x (4 to 2/0)	1x (2 to 2/0)	1x (1/0 to 2/0)	1x (2/0 to 3/0)	1x (4/0 to 300)	1x (300)	2x (2/0 to 300)	2x (3/0 to 300)	2x (4/0 to 350)	2x (4/0 to 350)	-----
440 to 480	1x (4)	1x (3 to 2/0)	1x (2 to 2/0)	1x (1/0 to 3/0)	1x (2/0 to 3/0)	1x (4/0 to 300)	1x (300)	2x (1/0 to 300)	2x (2/0 to 300)	2x (3/0 to 350)	2x (4/0 to 350)
600	1x (6 to 4)	1x (4)	1x (3 to 2/0)	1x (2 to 2/0)	1x (1/0 to 3/0)	1x (2/0 to 3/0)	1x (4/0 to 300)	1x (250 to 300)	1x (300)	2x (1/0 to 300)	2x (2/0 to 300)

Motor Terminals

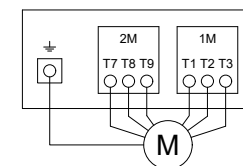

Model: GPP

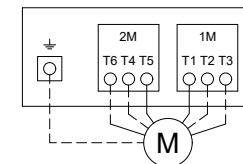

Models: GPY/GPW

ALUMINUM CONDUCTORS for Contactor (1M-2M).

Field Wiring According to Bending Space (AWG or MCM). Terminals T1-T2-T3-T4-T5-T6-T7-T8-T9

HP Voltage	5	7.5	10	15	20	25	30	40	50	60
208	1x (12 to 2/0) **	1x (10 to 2/0) **	1x (10 to 2/0) **	1x (8 to 2/0) **	1x (6 to 2/0) **	1x (4 to 2/0) **	1x (4 to 2/0) **	1x (2 to 2/0)	1x (1/0 to 2/0)	1x (2/0)
220 to 240	1x (12 to 2/0) **	1x (10 to 2/0) **	1x (10 to 2/0) **	1x (8 to 2/0) **	1x (8 to 2/0) **	1x (6 to 2/0) **	1x (4 to 2/0) **	1x (2 to 2/0) **	1x (1 to 2/0)	1x (1/0 to 2/0)
380 to 416	1x (12 to 2/0) **	1x (12 to 2/0) **	1x (12 to 2/0) **	1x (10 to 2/0) **	1x (10 to 2/0) **	1x (8 to 2/0) **	1x (8 to 2/0) **	1x (6 to 2/0) **	1x (4 to 2/0) **	1x (3 to 2/0) **
440 to 480	1x (12 to 2/0) **	1x (12 to 2/0) **	1x (12 to 2/0) **	1x (12 to 2/0) **	1x (10 to 2/0) **	1x (10 to 2/0) **	1x (8 to 2/0) **	1x (8 to 2/0) **	1x (6 to 2/0) **	1x (4 to 2/0) **
600	1x (12 to 2/0) **	1x (12 to 2/0) **	1x (12 to 2/0) **	1x (12 to 2/0) **	1x (10 to 2/0) **	1x (10 to 2/0) **	1x (10 to 2/0) **	1x (8 to 2/0) **	1x (8 to 2/0) **	1x (6 to 2/0) **

HP Voltage	75	100	125	150	200	250	300	350	400	450	500
208	1x (3/0)	Consult Factory	1x (300) 90°C *	2x (3/0 to 300)	2x (250 to 350)	-----	-----	-----	-----	-----	-----
220 to 240	1x (2/0) 90°C *	Consult Factory	1x (300)	1x (300) 90°C *	2x (4/0 to 300)	2x (300 to 350)	-----	-----	-----	-----	-----
380 to 416	1x (2 to 2/0)	1x (1/0 to 2/0)	1x (1/0 to 2/0)	1x (3/0) 90°C *	1x (300)	1x (300) 90°C *	2x (4/0 to 300)	2x (250 to 300)	2x (300 to 350)	2x (300 to 350)	-----
440 to 480	1x (3 to 2/0) **	1x (2 to 2/0)	1x (2/0) 90°C *	1x (2/0 to 3/0)	1x (3/0) 90°C *	1x (300)	1x (300) 90°C *	2x (3/0 to 300)	2x (4/0 to 300)	2x (250 to 350)	2x (300 to 350)
600	1x (4 to 2/0) **	1x (3 to 2/0) **	1x (2 to 2/0)	1x (1/0 to 3/0)	1x (3/0)	1x (3/0) 90°C *	1x (300)	1x (300) 90°C *	Consult Factory	2x (3/0 to 300)	2x (4/0 to 300)

*For standard enclosure, use 90°C aluminium wire. Consult Factory for Use of Conductors Rated Lower than 90°C.

** Option V659 required.

Notes:

- 1 - For proper wire sizing, refer to NFPA70 and NEC (USA) or CEC (Canada) or local code.
- 2 - Controller suitable for service entrance in USA.
- 3 - For more accurate motor connections refer to motor manufacturer or motor nameplate.
- 4 - Controller is phase sensitive. Incoming lines must be connected in ABC sequence.

Drawing for information only.
Manufacturer reserves the right to modify this drawing without notice.
Contact manufacturer for "As Built" drawing.



BY DD/MM/YY

DRAWN BY ACD 18/12/23

FINAL APPROVAL FC 19/12/23

© Tornatech, Inc. Not for construction. Subject to change without notice.

ELECTRIC FIRE PUMP CONTROLLER

MODEL:GPX

BUILT TO THE LATEST EDITION OF THE NFPA20 & NFPA70



DRAWING NUMBER
GPX-TD803/E
DWG REV. 0
SHEET 1 OF 1

Field Connections

Terminals Wire Size:
24 - 12 AWG
0.5 Nm

- Remote Manual
- Lockout
- Remote Auto
- Deluge Valve
- Low Water Level

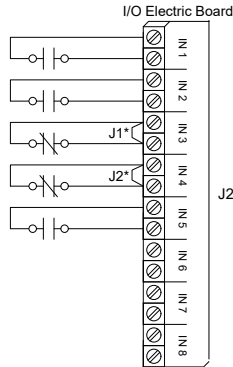

Network Connections

Terminals Wire Size:
Shielded Female Connector RJ45

Modbus TCP/IP RJ45

Located on Main Board



Alarm Contacts

Terminals Wire Size:
24 - 12 AWG
0.5 Nm

Motor Run

Power Available

Normal Power Phase Reversal

Pump Room Alarm**

Motor Trouble**

(Field Programmable****)

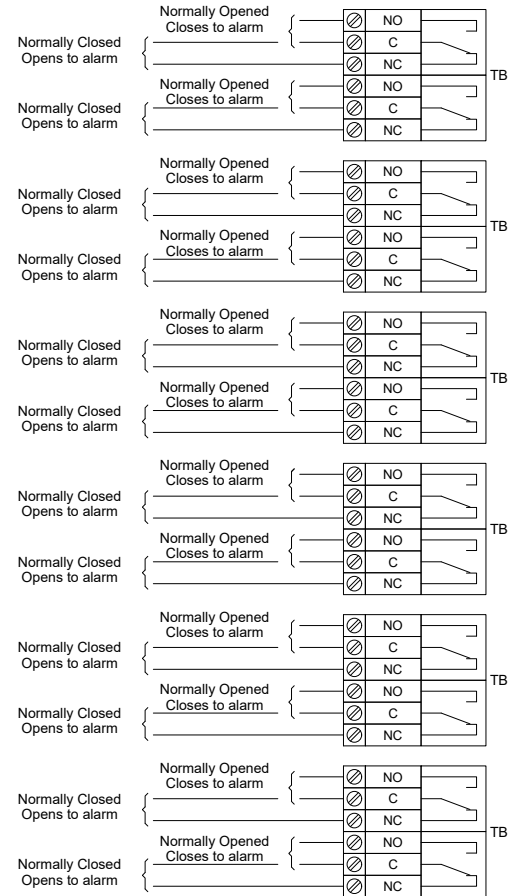

* Remove jumper to use this feature
 ** Re-assignable
 **** Not available on GPS models



© Tornatech, Inc. Not for construction. Subject to change without notice.

	BY	DD/MM/YY
DRAWN BY	ACD	28/02/23
FINAL APPROVAL	FC	28/02/23

AUTOMATIC TRANSFER SWITCH FOR ELECTRIC FIRE PUMP CONTROLLER

MODEL: GPU
BUILT TO THE LATEST EDITION OF THE NFPA20 & NFPA70



DRAWING NUMBER	GPU-TD801/E
DWG REV. 0	
SHEET 1 OF 1	

Remote Alarm Terminals (TSB1)

Terminals Wire Size:
24 - 12 AWG
0.5 Nm

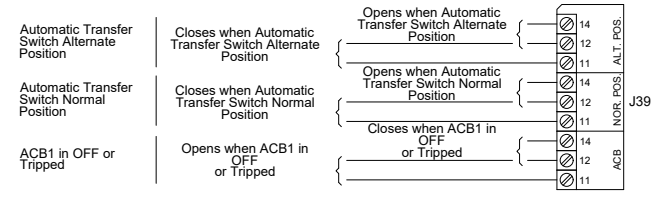

Control Terminals (TSB1)

Terminals Wire Size:
24 - 12 AWG
0.5 Nm

