



TORNATECH

Project: _____

Customer: _____

Engineer: _____

Pump Manufacturer: _____

Technical Data Submittal Document

GPx Series

Full Service
Electric Fire Pump Controller



Contents:

Data Sheets
Dimensional Data
Wiring Schematics
Field Connections

Note: The drawings included in this package are for controllers covered under our standard offering. Actual AS BUILT drawings may differ from what is shown in this package.



June 2022

Select starting method
Model GPA
Across the line

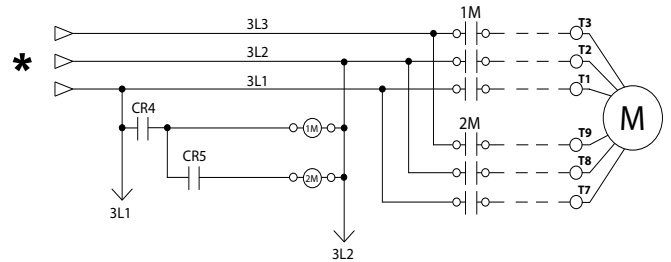
Model GPP
Partwinding

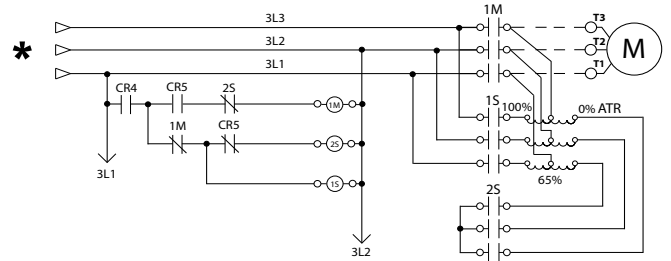
Model GPS
Soft Start Soft Stop

Model GPR
Autotransformer

Model GPY
Wye-Delta Open

Model GPW
Wye-Delta Closed

*From normal incoming power through Disconnecting Means (IS/CB)





| | | | |
|---|--|--|------|
| Standard, Listings, Approvals and Certifications | Built to NFPA 20 (latest edition) | | |
| | Underwriters Laboratory (UL) | UL218 - Fire Pump Controllers | |
| | FM Global | Class 1321/1323 | |
| | New York City | Accepted for use in the City of New York by the Department of Buildings | |
| | CE Mark | Various EN, IEC & CEE directives and standards | |
| | Built in Canada or U.A.E | Built in Europe | |
| | CE Mark Option | Supplied as Standard | |
| Enclosure | Protection Rating | | |
| | Built in Canada or U.A.E | Built in Europe | |
| | Standard: NEMA 2 | Standard: IP55 | |
| | Optional | | |
| | NEMA 12 | NEMA 4X-304 sst painted | IP54 |
| | NEMA 3 | NEMA 4X-304 sst brushed finish | IP55 |
| | NEMA 3R | NEMA 4X-316 sst painted | IP65 |
| | NEMA 4 | NEMA 4X-316 sst brushed finish | IP66 |
| | Accessories • Bottom entry gland plate • Lifting Lugs • Keylock handle | Paint Specifications • Red RAL3002 • Powder coating • Glossy textured finish | |

| Shortcircuit Withstand Rating | 200V to 208V 60Hz | 220V to 240V 60Hz | 380V to 415V 50 Hz / 60Hz | 440V to 480V 60Hz | 575V to 600V 60Hz |
|-------------------------------|----------------------|----------------------|------------------------------|-----------------------|----------------------|
| | HP (kw) | | | | |
| Standard 100kA | 5 - 150 (3.7 - 110) | 5 - 200 (3.7 - 149) | 5 - 300 (3.7 - 223) | 5 - 400 (3.7 - 298) | N/A |
| Optional 150kA | | | | | |
| Standard 50kA | 200 (149) | 250 (186) | 350 - 450 (261-335) | 450 - 500 (335 - 373) | 5 - 500 (3.7- 373) |
| Optional 100kA | N/A | N/A | 350 - 500 (261 - 373) | 450 - 500 (335 - 373) | |
| Optional 200kA | 5 - 150 (3.7 - 110) | 5 - 200 (3.7 - 149) | 5 - 300 (3.7 - 223) | 5 - 400 (3.7 - 298) | N/A |

*Please see Disconnecting Means details on page 4



| | |
|------------------------------------|---|
| Ambient Temperature Rating | <p>Standard: 4°C to 40°C / 39°F to 104°F</p> <p>Optional: 4°C to 55°C / 39°F to 131°F</p> <p>Controllers built in Dubai, UAE (Tornatech FZE) are supplied standard with 55°C rating.</p> |
| Surge Suppression | Surge arrestor rated to suppress surges above line voltage |
| Disconnecting Means | <ul style="list-style-type: none"> • Isolating switch and circuit breaker assembly: <ul style="list-style-type: none"> - Door interlocked in the ON position - Isolating switch rated not less than 115% of motor full load current - Circuit breaker continuous rating not less than 115% of motor full load current - Overcurrent sensing non-thermal type, magnetic only - Instantaneous trip setting of not more than 20 times the motor full load current • Common flange mounted operating handle |
| Service Entrance Rating | Suitable as service entrance equipment |
| Emergency Start Handle | <ul style="list-style-type: none"> • Flange mounted • Pull and latch activation • Integrated limit switch • Across the line start (direct on line) |
| Locked Rotor Protector | <ul style="list-style-type: none"> • Operate shunt trip to open circuit breaker • Factory set at 600% of motor full load current • Trip between 8 and 20 seconds |
| Electrical Readings | <ul style="list-style-type: none"> • Voltage phase to phase (normal power) • Amperage of each phase when motor is running |
| Pressure Readings | <ul style="list-style-type: none"> • Continuous system pressure display • Cut-in and Cut-out pressure settings |
| Pressure and Event recorder | <ul style="list-style-type: none"> • Pressure readings with date stamp • Event recording with date stamp • Under regular maintained operation, events are stored in memory for the life of the controller. • Data viewable on operator interface display screen • Downloadable by USB port to external memory device |
| Pressure Sensing | <ul style="list-style-type: none"> • Pressure transducer and run test solenoid valve assembly for fresh water application • Pressure sensing line connection 1/2" Female NPT • Drain connection 3/8" • Rated for 0-500PSI working pressure (standard display at 0-300PSI) • Externally mounted with protective cover |



| | | | |
|------------------------------------|---|--|---|
| Audible Alarm | 6" alarm bell - 85 dB at 10ft. (3m) | | |
| Visual Indications | <ul style="list-style-type: none"> • Power available • Motor run • Periodic test • Manual start | <ul style="list-style-type: none"> • Deluge valve start • Remote automatic start • Remote manual start • Emergency start | <ul style="list-style-type: none"> • Pump on demand/Automatic start • Pump room temperature (°F or °C) • Lockout |
| Visual & Audible Alarms | <p>Visual</p> <ul style="list-style-type: none"> • Control voltage not healthy • Invalid cut-in • Lock rotor current • Loss of power • Low ambient temperature • Low water level • Motor trouble • Phase reversal (normal power) <p>Visual and audible</p> <ul style="list-style-type: none"> • Fail to start | | |
| Remote Alarm Contacts | <p>DPDT-8A-250V.AC</p> <ul style="list-style-type: none"> • Power available • Phase reversal • Motor run • Common pump room alarm (field re-assignable)** <ul style="list-style-type: none"> • Overvoltage • Undervoltage • Phase unbalance • Low pump room temperature • High Pump room temperature • Common motor trouble (field re-assignable)** <ul style="list-style-type: none"> • Overcurrent • Fail to start • Undercurrent • Ground fault • Free (field programmable)** | | |

**Tornatech reserves the right to use any of these three alarm points for special specific application requirements.



| | | | |
|---|---|---|--|
| <p>ViZiTouch V2 Operator Interface</p> | <ul style="list-style-type: none"> • Embedded microcomputer with software PLC logic • 7.0" color touch screen (HMI technology) • Upgradable software • Multi-language | | |
| <p>Communication Protocol Capability</p> | <ul style="list-style-type: none"> • Protocol: Modbus • Connection type: Shielded female connector RJ45 • Frame Format: TCP/IP • Addresses: See bulletin MOD-GPx | | |
| <p>Operation</p> | <p>Automatic Start</p> | <ul style="list-style-type: none"> • Start on pressure drop • Remote start signal from automatic device • Deluge valve start | |
| | <p>Manual Start</p> | <ul style="list-style-type: none"> • Start pushbutton • Run test pushbutton • Remote start from manual device | |
| | <p>Stopping</p> | <ul style="list-style-type: none"> • Manual with Stop pushbutton • Automatic after expiration of minimum run timer *** | |
| | <p>Timers</p> | <p>Field Adjustable & Visual Countdown</p> | <ul style="list-style-type: none"> • Minimum run timer ***(off delay) • Sequential start timer (on delay) • Periodic test timer |
| | <p>Actuation</p> | <p>Visual Indication</p> | <ul style="list-style-type: none"> • Pressure • Non-pressure |
| | <p>Mode</p> | | <ul style="list-style-type: none"> • Automatic • Non-automatic |

***Can only be used if approved by the AHJ



| | | | |
|------|--|------|--|
| A4 | Flow switch provision | C19 | Emergency start alarm contact (DPDT) |
| A8 | Foam pump application w/o pressure transducer and run test solenoid valve. | C20 | Manual start alarm contact (DPDT) |
| A9 | Low zone pump control function | C21 | Deluge valve start alarm contact (DPDT) |
| A10 | Middle zone pump control function | C22 | Remote automatic start alarm contact (DPDT) |
| A11 | High zone pump control function | C23 | Remote manual start alarm contact (DPDT) |
| A13 | Non-pressure actuated controller w/o pressure transducer and run test solenoid valve | C24 | High pump room temperature alarm contact (DPDT) |
| A16 | Lockout/interlock circuit from equipment installed inside the pump room | C25 | Second set of standard alarm contacts (DPDT) (Typical for city of Los Angeles and Denver) |
| B11 | Built in alarm panel (120V.AC supervisory power) providing indication for: • Audible alarm & silence pushbutton for motor run, phase reversal, loss of phase. • Pilot lights for loss of phase & supervisory power available | Cx | Additional visual and alarm contact (Specify function) (DPDT) |
| B11B | Built in alarm panel same as B11 but 220-240VAC supervisory power | D1 | Low suction pressure transducer for fresh water rated at 0-300PSI with visual indication and alarm contact |
| B19A | High motor temperature c/w thermostat relay and alarm contacts (DPDT) | D1A | Low suction pressure transducer for sea water rated at 0-300PSI with visual indication and alarm contact |
| B19B | High motor temperature c/w PT100 relay and alarm contacts (DPDT) | D5 | Pressure transducer and run test solenoid valve for fresh water rated for 0-500PSI (for factory calibration purposes only) |
| B21 | Ground fault alarm detection c/w visual indication and alarm contact (DPDT) | D5D | Pressure transducer and run test solenoid valve for sea water rated for 0-500PSI |
| C1 | Extra motor run alarm contact (DPDT) | D10 | Omit mounting feet (when applicable) |
| C4 | Periodic test alarm contact (DPDT) | D13 | High withstand rating for: • 200V to 208V @ 150HP max. = 150kA* • 200V to 208V @ 200HP = 100kA* • 220V to 240V @ 200HP max. = 150kA* • 220V to 240V @ 250HP = 100kA* • 380V to 415V @ 300HP max. = 150kA* • 380V to 415V @ 350HP to 450HP = 100kA* • 440V to 480V @ 400HP max. = 150kA* • 440V to 480V @ 450HP to 500HP = 100kA* • 600V @ 500HP max. = 100kA* |
| C6 | Low discharge pressure alarm contact (DPDT) | D13A | High withstand rating for: • 380V to 480V = 65kA* • 600V = 25kA* |
| C7 | Low pump room temperature alarm contact (DPDT) | D13B | High withstand rating for: • 200V to 208V @ 150HP max. = 200kA* • 220V to 240V @ 200HP max. = 200kA* • 380V to 415V @ 300HP max. = 200kA* • 440V to 480V @ 400HP max. = 200kA* |
| C10 | Low water reservoir level alarm contact (DPDT) | D14 | Anti-condensation heater & thermostat |
| C11 | High electric motor temperature alarm contact (DPDT) | D14A | Anti-condensation heater & humidistat |
| C12 | High electric motor vibration c/w visual indication and alarm contact (DPDT) | D14B | Anti-condensation heater & thermostat & humidistat |
| C14 | Pump on demand / automatic start alarm contact (DPDT) | | |
| C15 | Pump fail to start alarm contact (DPDT) | | |
| C16 | Control voltage healthy alarm contact (DPDT) | | |
| C17 | Flow meter valve loop open c/w visual indication and alarm contact (DPDT) | | |
| C18 | High water reservoir level c/w visual indication and alarm contact (DPDT) | | |

*For fire pump controller section only.

Note: Options chosen from this page are not electrically represented on the wiring schematics in this submittal package.



| | |
|------|--|
| D15 | Tropicalization |
| D18 | CE Mark with factory certificate |
| D26 | Modbus with RTU frame format and RS485 connection |
| D27 | Motor heater connection (external single phase power source and heater on/off contact) |
| D27A | Motor heater connection (internal single phase power source and heater on/off contact) |
| D28 | Customized drawing set |
| D34A | Field programmable I/O board - 5 Input / 5 output |
| D43 | Seismic Certification compliant to CBC 2019, IBC 2018 rigid base/wall mounted only |
| D44 | Special Seismic Certification compliant to OSHPD rigid base/wall mounted only |

| | |
|-----|--|
| L01 | Other language and English (bilingual) |
| L02 | French |
| L03 | Spanish |
| L04 | German |
| L05 | Italian |
| L06 | Polish |
| L07 | Romanian |
| L08 | Hungarian |
| L09 | Slovak |
| L10 | Croatian |
| L11 | Czech |
| L12 | Portuguese |
| L13 | Dutch |
| L14 | Russian |
| L15 | Turkish |
| L16 | Swedish |
| L17 | Bulgarian |
| L18 | Thai |
| L19 | Indonesian |
| L20 | Slovenian |
| L21 | Danish |
| L22 | Greek |
| L23 | Arabic |
| L24 | Hebrew |
| L25 | Chinese |

Additional Options:

Note: Options chosen from this page are not electrically represented on the wiring schematics in this submittal package.

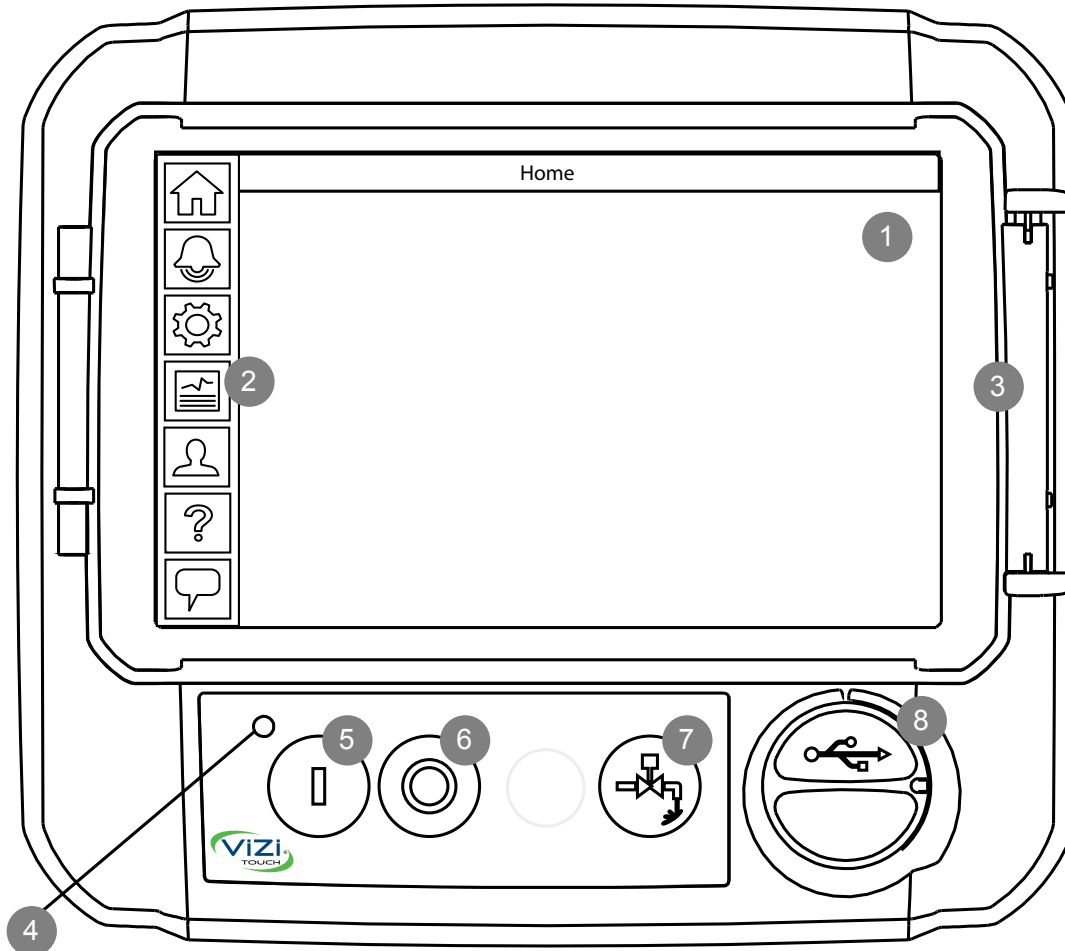
ViZiTouch V2 Operator Interface

- | | |
|------------------------|--------------------------|
| 1 - Color touch screen | 3 - Screen protector |
| 2 - Onscreen menu | 4 - Power LED (3 colors) |
| • HOME page | 5 - START button |
| • ALARM page | 6 - STOP button |
| • CONFIGURATION page | 7 - RUN TEST button |
| • HISTORY page | 8 - USB port |
| • SERVICE page | |
| • MANUAL page | |
| • LANGUAGES page | |

Electric Fire Pump Controller

Model: GPR/GPW

Dimensions

Built to the latest edition of the NFPA 20 standard

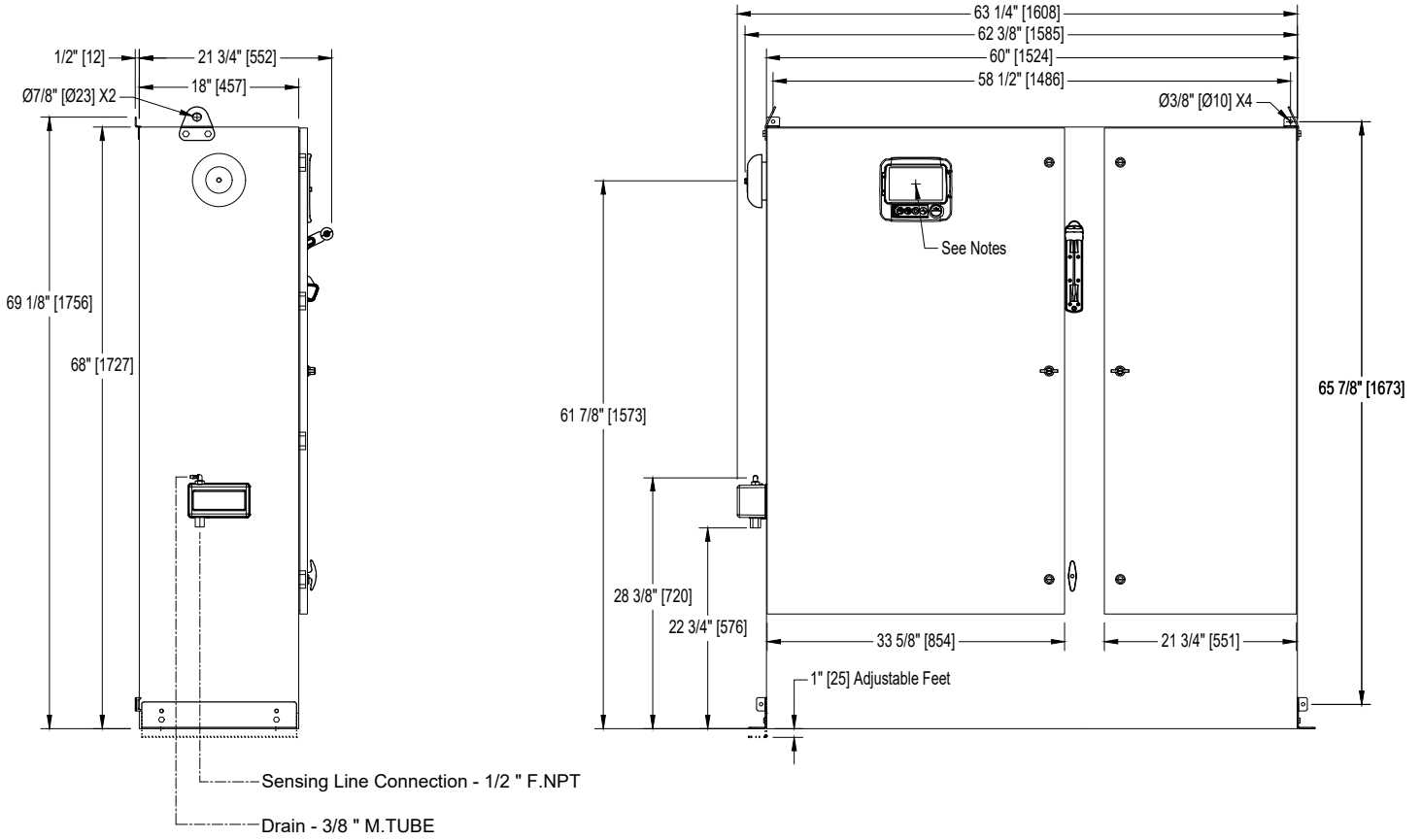

| Voltage | Min HP | Max HP |
|-----------------|----------------|--------|
| 208 | 200 | |
| 220 - 240 | 250 | |
| 380 - 400 - 415 | 350 | 450 |
| 440 - 480 | 500 | |
| 600 | Not Applicable | |

Notes:

- Standard NEMA: NEMA 2
- Standard paint : textured red RAL 3002.
- All dimensions are in inches [millimeters].
- Center of ViZiTouch screen: 61-5/8" [1564] from Bottom.
- Bottom conduit entrance through removable gland plate recommended.
- Use watertight conduit and connector only.
- Protect equipment against drilling chips.
- Door swing equal to door width.

Drawing for information only.
 Manufacturer reserves the right to modify this drawing without notice.
 Contact manufacturer for "As Built" drawing.

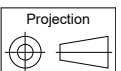

| REV. | DESCRIPTION | DD/MM/YY | Drawing number |
|------|------------------------------------|----------|----------------|
| 3. | Removed Seismic logo (optional) | 18/05/22 | GPX-DI371 /E |
| 2. | New Logo | 10/05/18 | |
| 1. | Box Size Revision and Valve Change | 21/11/17 | |

Electric Fire Pump Controller Reduced Voltage / Wye-Delta (Closed Transition)

Model: GPW

Wiring schematic

Built to the latest edition of the NFPA 20 standard

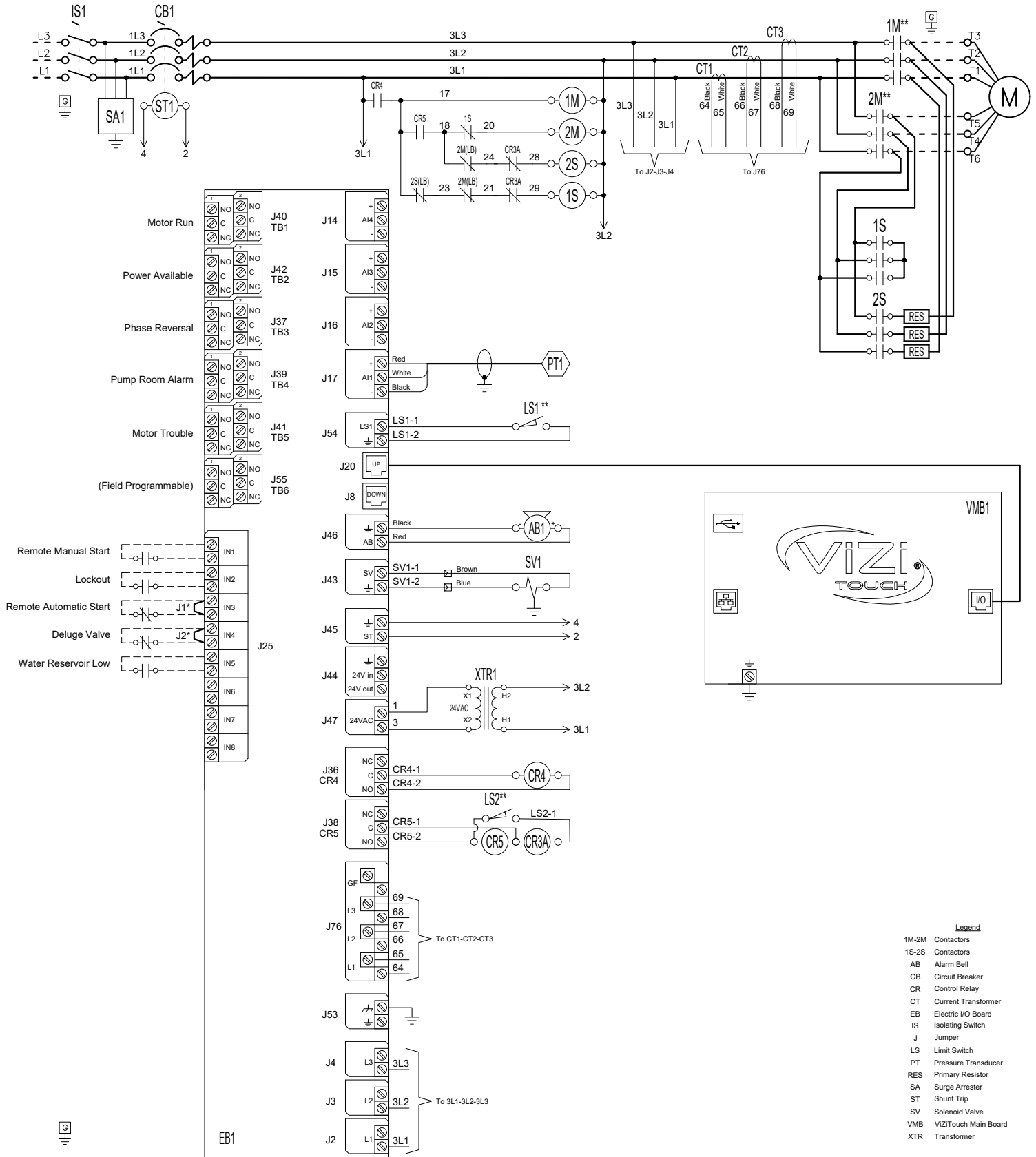

* Remove jumper to use this feature

** Contact closes when emergency start is in "ON" position

Drawing for information only.
Manufacturer reserves the right to modify this drawing without notice.
Contact manufacturer for "As Built" drawing.



| REV. | DESCRIPTION | DD/MM/YY | Drawing number |
|------|---|----------|----------------|
| 3 | Removed Seismic logo (optional) | 18/05/22 | GPW-WS600 /E |
| 2 | Update Logo | 23/04/18 | |
| 1 | Removed (fail safe) text from Power Available relay | 20/02/17 | |

Electric Fire Pump Controller

Model: GPX

Terminal Diagram and Sizing for Isolating Switch

Built to the latest edition of the NFPA 20 standard

Power Terminals

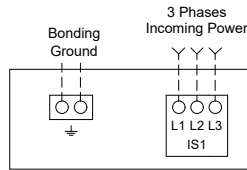

Notes:

- 1 - For proper wire sizing, refer to NFPA70 and NEC (USA) or CEC (Canada) or local code.
- 2 - Controller suitable for service entrance in USA.
- 3 - For more accurate motor connections refer to motor manufacturer or motor nameplate.
- 4 - Controller is phase sensitive. Incoming lines must be connected in ABC sequence.

COPPER CONDUCTORS for Isolating Switch (IS1).

Field Wiring According to Bending Space (AWG or MCM). Terminals L1 - L2 - L3

| Bending Space | 5" (127 mm) | | | | | | | 8" (203 mm) | | |
|---------------|----------------|----------------|----------------|----------------|----------------|---------------|---------------|-----------------|-----------------|-----------------|
| | HP | 5 | 7.5 | 10 | 15 | 20 | 25 | 30 | 40 | 50 |
| 208 | 1x (10 to 1/0) | 1x (8 to 1/0) | 1x (8 to 1/0) | 1x (6 to 1/0) | 1x (4 to 1/0) | 1x (3 to 1/0) | 1x (2 to 1/0) | 1x (1/0 to 3/0) | 1x (3/0 to 250) | 1x (4/0 to 250) |
| 220 to 240 | 1x (10 to 1/0) | 1x (10 to 1/0) | 1x (8 to 1/0) | 1x (6 to 1/0) | 1x (4 to 1/0) | 1x (4 to 1/0) | 1x (3 to 1/0) | 1x (1 to 3/0) | 1x (2/0 to 3/0) | 1x (3/0 to 250) |
| 380 to 416 | 1x (10 to 1/0) | 1x (10 to 1/0) | 1x (10 to 1/0) | 1x (8 to 1/0) | 1x (8 to 1/0) | 1x (6 to 1/0) | 1x (6 to 1/0) | 1x (4 to 1/0) | 1x (3 to 1/0) | 1x (3 to 1/0) |
| 440 to 480 | 1x (10 to 1/0) | 1x (10 to 1/0) | 1x (10 to 1/0) | 1x (10 to 1/0) | 1x (8 to 1/0) | 1x (8 to 1/0) | 1x (6 to 1/0) | 1x (6 to 1/0) | 1x (4 to 1/0) | 1x (3 to 1/0) |
| 600 | 1x (10 to 1/0) | 1x (10 to 1/0) | 1x (10 to 1/0) | 1x (10 to 1/0) | 1x (10 to 1/0) | 1x (8 to 1/0) | 1x (8 to 1/0) | 1x (6 to 1/0) | 1x (6 to 1/0) | 1x (4 to 1/0) |

| Bending Space | 12" (305 mm) | | | | 16" (406 mm) | | | | | | | |
|---------------|-----------------|-----------------|-----------------|-----------------|-----------------|-----------------|-----------------|-----------------|-----------------|-----------------|-----------------|-----------------|
| | HP | 75 | 100 | 125 | 150 | 200 | 250 | 300 | 350 | 400 | 450 | 500 |
| 208 | 2x (1/0 to 500) | 2x (2/0 to 500) | 2x (4/0 to 500) | 2x (250 to 500) | 3x (4/0 to 500) | ----- | ----- | ----- | ----- | ----- | ----- | ----- |
| 220 to 240 | 1x (250) | 2x (2/0 to 500) | 2x (3/0 to 500) | 2x (4/0 to 500) | 2x (350 to 500) | 3x (250 to 500) | ----- | ----- | ----- | ----- | ----- | ----- |
| 380 to 416 | 1x (1/0 to 3/0) | 1x (3/0 to 250) | 1x (250) | 2x (1/0 to 500) | 2x (3/0 to 500) | 2x (4/0 to 500) | 2x (300 to 500) | 2x (400 to 500) | 3x (250 to 500) | 3x (300 to 500) | ----- | ----- |
| 440 to 480 | 1x (1 to 3/0) | 1x (2/0 to 3/0) | 1x (3/0 to 250) | 1x (4/0 to 250) | 2x (1/0 to 500) | 2x (3/0 to 500) | 2x (4/0 to 500) | 2x (300 to 500) | 2x (350 to 500) | 2x (400 to 500) | 3x (250 to 500) | ----- |
| 600 | 1x (3 to 1/0) | 1x (1 to 3/0) | 1x (2/0 to 3/0) | 1x (3/0 to 250) | 1x (250) | 2x (2/0 to 500) | 2x (3/0 to 500) | 2x (4/0 to 500) | 2x (250 to 500) | 2x (300 to 500) | 2x (350 to 500) | 2x (350 to 500) |

ALUMINUM CONDUCTORS for Isolating Switch (IS1).

Field Wiring According to Bending Space (AWG or MCM). Terminals L1 - L2 - L3

| Bending Space | 5" (127 mm) | | | | | | | 8" (203 mm) | | 10" (254 mm) |
|---------------|----------------|----------------|----------------|----------------|---------------|---------------|---------------|-----------------|-----------------|------------------------------|
| | HP | 5 | 7.5 | 10 | 15 | 20 | 25 | 30 | 40 | 50 |
| 208 | 1x (10 to 1/0) | 1x (6 to 1/0) | 1x (6 to 1/0) | 1x (4 to 1/0) | 1x (3 to 1/0) | 1x (1 to 1/0) | 1x (1/0) | 1x (3/0) | 1x (4/0 to 250) | 1x (300)** or 1x (250) 90°C* |
| 220 to 240 | 1x (10 to 1/0) | 1x (8 to 1/0) | 1x (6 to 1/0) | 1x (4 to 1/0) | 1x (3 to 1/0) | 1x (2 to 1/0) | 1x (1 to 1/0) | 1x (2/0 to 3/0) | 1x (3/0) 90°C* | 1x (250) |
| 380 to 416 | 1x (10 to 1/0) | 1x (10 to 1/0) | 1x (10 to 1/0) | 1x (6 to 1/0) | 1x (6 to 1/0) | 1x (4 to 1/0) | 1x (4 to 1/0) | 1x (2 to 1/0) | 1x (1 to 1/0) | 1x (1/0) |
| 440 to 480 | 1x (10 to 1/0) | 1x (10 to 1/0) | 1x (10 to 1/0) | 1x (8 to 1/0) | 1x (6 to 1/0) | 1x (6 to 1/0) | 1x (6 to 1/0) | 1x (4 to 1/0) | 1x (2 to 1/0) | 1x (1 to 1/0) |
| 600 | 1x (10 to 1/0) | 1x (10 to 1/0) | 1x (10 to 1/0) | 1x (10 to 1/0) | 1x (8 to 1/0) | 1x (6 to 1/0) | 1x (6 to 1/0) | 1x (4 to 1/0) | 1x (4 to 1/0) | 1x (2 to 1/0) |

| Bending Space | 12" (305 mm) | | | | 16" (406 mm) | | | | | | | |
|---------------|-------------------|-----------------|-------------------|-------------------------------------|-----------------|-----------------|-----------------|-------------------------------------|-----------------|-----------------|-----------------|----------|
| | HP | 75 | 100 | 125 | 150 | 200 | 250 | 300 | 350 | 400 | 450 | 500 |
| 208 | 2x (2/0 to 500) | 2x (4/0 to 500) | 2x (300 to 500) | 2x (350 to 500) | 3x (300 to 500) | ----- | ----- | ----- | ----- | ----- | ----- | ----- |
| 220 to 240 | 1x (350)** N/A | 2x (3/0 to 500) | 2x (250 to 500) | 2x (300 to 500) | 2x (500) | 3x (400 to 500) | ----- | ----- | ----- | ----- | ----- | ----- |
| 380 to 416 | 1x (3/0) | 1x (250 to 350) | 1x (350)** N/A | 2x (3/0 to 500) | 2x (4/0 to 500) | 2x (300 to 500) | 2x (500) | 3x (300 to 500)** 2x (500) 90°C* | 3x (350 to 500) | 3x (400 to 500) | ----- | ----- |
| 440 to 480 | 1x (1/0 to 3/0) | 1x (3/0) | 1x (250) | 1x (300 to 350)** 1x (250) 90°C* | 2x (3/0 to 500) | 2x (250 to 500) | 2x (300 to 500) | 2x (400 to 500) | 2x (500) | 2x (500) 90°C* | 3x (350 to 500) | ----- |
| 600 | 1x (1 to 1/0) | 1x (2/0 to 3/0) | 1x (3/0) 90°C* | 1x (4/0 to 250) | 1x (350 to 500) | 2x (3/0 to 500) | 2x (4/0 to 250) | 2x (300 to 500) | 2x (350 to 500) | 2x (400 to 500) | 2x (400 to 500) | 2x (500) |

*For standard enclosure, use 90°C aluminium wire. Consult Factory for Use of Conductors Rated Lower than 90°C.
** Consult Factory

Drawing for information only.
Manufacturer reserves the right to modify this drawing without notice.
Contact manufacturer for "As Built" drawing.



| REV. | DESCRIPTION | DD/MM/YY | Drawing number |
|------|---------------------------------|----------|------------------|
| 1 | Removed Seismic logo (optional) | 18/05/22 | GPX-TD612 1/2 /E |
| 0 | First issue | 22/12/20 | |

Electric Fire Pump Controller

Model: GPX

Terminal Diagram and Sizing For GPP, GPY & GPW

Built to the latest edition of the NFPA 20 standard

Motor Terminals



Model : GPP



Models : GPW & GPY

Notes:

- 1 - For proper wire sizing, refer to NFPA70 and NEC (USA) or CEC (Canada) or local code.
- 2 - Controller suitable for service entrance in USA.
- 3 - For more accurate motor connections refer to motor manufacturer or motor nameplate.
- 4 - Controller is phase sensitive. Incoming lines must be connected in ABC sequence.

COPPER CONDUCTORS for Motor Connection (1M-2M).

Field Wiring According to Bending Space (AWG or MCM). Terminals T1-T2-T3-T4-T5-T6-T7-T8-T9

| HP Voltage | 5 | 7.5 | 10 | 15 | 20 | 25 | 30 | 40 | 50 | 60 |
|---------------|--------------|--------------|--------------|--------------|--------------|--------------|--------------|---------------|---------------|---------------|
| 208 | 1x (10 to 4) | 1x (10 to 4) | 1x (10 to 4) | 1x (8 to 4) | 1x (8 to 4) | 1x (6 to 4) | 1x (6 to 4) | 1x (4 to 2/0) | 1x (2 to 2/0) | 1x (1 to 2/0) |
| 220 to 240 | 1x (10 to 4) | 1x (10 to 4) | 1x (10 to 4) | 1x (8 to 4) | 1x (8 to 4) | 1x (6 to 4) | 1x (6 to 4) | 1x (4) | 1x (3 to 2/0) | 1x (2 to 2/0) |
| 380 to 416 | 1x (10 to 4) | 1x (10 to 4) | 1x (10 to 4) | 1x (10 to 4) | 1x (10 to 4) | 1x (10 to 4) | 1x (8 to 4) | 1x (8 to 4) | 1x (6 to 4) | 1x (4) |
| 440 to 480 | 1x (10 to 4) | 1x (10 to 4) | 1x (10 to 4) | 1x (10 to 4) | 1x (10 to 4) | 1x (10 to 4) | 1x (10 to 4) | 1x (8 to 4) | 1x (8 to 4) | 1x (6 to 4) |
| 600 | 1x (10 to 4) | 1x (10 to 4) | 1x (10 to 4) | 1x (10 to 4) | 1x (10 to 4) | 1x (10 to 4) | 1x (10 to 4) | 1x (10 to 4) | 1x (8 to 4) | 1x (8 to 4) |

| HP Voltage | 75 | 100 | 125 | 150 | 200 | 250 | 300 | 350 | 400 | 450 | 500 |
|---------------|-----------------|-----------------|-----------------|-----------------|-----------------|-----------------|-----------------|-----------------|-----------------|-----------------|-----------------|
| 208 | 1x (2/0 to 3/0) | 1x (3/0 to 300) | 1x (250 to 300) | 2x (1/0 to 300) | 2x (3/0 to 350) | ----- | ----- | ----- | ----- | ----- | ----- |
| 220 to 240 | 1x (1/0 to 2/0) | 1x (3/0) | 1x (4/0 to 300) | 1x (300) | 2x (2/0 to 300) | 2x (4/0 to 350) | ----- | ----- | ----- | ----- | ----- |
| 380 to 416 | 1x (4 to 2/0) | 1x (2 to 2/0) | 1x (1/0 to 2/0) | 1x (2/0 to 3/0) | 1x (4/0 to 300) | 1x (300) | 2x (2/0 to 300) | 2x (3/0 to 300) | 2x (4/0 to 350) | 2x (4/0 to 350) | ----- |
| 440 to 480 | 1x (4 to 2/0) | 1x (3 to 2/0) | 1x (2 to 2/0) | 1x (1/0 to 3/0) | 1x (2/0 to 3/0) | 1x (4/0 to 300) | 1x (300) | 2x (1/0 to 300) | 2x (2/0 to 300) | 2x (3/0 to 350) | 2x (4/0 to 350) |
| 600 | 1x (6 to 4) | 1x (4) | 1x (3 to 2/0) | 1x (2 to 2/0) | 1x (1/0 to 3/0) | 1x (2/0 to 3/0) | 1x (4/0 to 300) | 1x (250 to 300) | 1x (300) | 2x (1/0 to 300) | 2x (2/0 to 300) |

ALUMINUM CONDUCTORS for Contactor (1M-2M).

Field Wiring According to Bending Space (AWG or MCM). Terminals T1-T2-T3-T4-T5-T6-T7-T8-T9

| HP Voltage | 5 | 7.5 | 10 | 15 | 20 | 25 | 30 | 40 | 50 | 60 |
|---------------|-------------------|-------------------|-------------------|-------------------|-------------------|-------------------|-------------------|------------------|------------------|------------------|
| 208 | 1x (12 to 2/0) ** | 1x (10 to 2/0) ** | 1x (10 to 2/0) ** | 1x (8 to 2/0) ** | 1x (6 to 2/0) ** | 1x (4 to 2/0) ** | 1x (4 to 2/0) ** | 1x (2 to 2/0) | 1x (1/0 to 2/0) | 1x (2/0) |
| 220 to 240 | 1x (12 to 2/0) ** | 1x (10 to 2/0) ** | 1x (10 to 2/0) ** | 1x (8 to 2/0) ** | 1x (8 to 2/0) ** | 1x (6 to 2/0) ** | 1x (4 to 2/0) ** | 1x (2 to 2/0) ** | 1x (1 to 2/0) | 1x (1/0 to 2/0) |
| 380 to 416 | 1x (12 to 2/0) ** | 1x (12 to 2/0) ** | 1x (12 to 2/0) ** | 1x (10 to 2/0) ** | 1x (10 to 2/0) ** | 1x (8 to 2/0) ** | 1x (8 to 2/0) ** | 1x (6 to 2/0) ** | 1x (4 to 2/0) ** | 1x (3 to 2/0) ** |
| 440 to 480 | 1x (12 to 2/0) ** | 1x (12 to 2/0) ** | 1x (12 to 2/0) ** | 1x (12 to 2/0) ** | 1x (10 to 2/0) ** | 1x (10 to 2/0) ** | 1x (8 to 2/0) ** | 1x (8 to 2/0) ** | 1x (6 to 2/0) ** | 1x (4 to 2/0) ** |
| 600 | 1x (12 to 2/0) ** | 1x (12 to 2/0) ** | 1x (12 to 2/0) ** | 1x (12 to 2/0) ** | 1x (10 to 2/0) ** | 1x (10 to 2/0) ** | 1x (10 to 2/0) ** | 1x (8 to 2/0) ** | 1x (8 to 2/0) ** | 1x (6 to 2/0) ** |

| HP Voltage | 75 | 100 | 125 | 150 | 200 | 250 | 300 | 350 | 400 | 450 | 500 |
|---------------|------------------|------------------|-----------------|-----------------|-----------------|-----------------|-----------------|-----------------|-----------------|-----------------|-----------------|
| 208 | 1x (3/0) | Consult Factory | 1x (300) 90°C * | 2x (3/0 to 300) | 2x (250 to 350) | ----- | ----- | ----- | ----- | ----- | ----- |
| 220 to 240 | 1x (2/0) 90°C * | Consult Factory | 1x (300) | 1x (300) 90°C * | 2x (4/0 to 300) | 2x (300 to 350) | ----- | ----- | ----- | ----- | ----- |
| 380 to 416 | 1x (2 to 2/0) | 1x (1/0 to 2/0) | 1x (1/0 to 2/0) | 1x (3/0) 90°C * | 1x (300) | 1x (300) 90°C * | 2x (4/0 to 300) | 2x (250 to 300) | 2x (300 to 350) | 2x (300 to 350) | ----- |
| 440 to 480 | 1x (3 to 2/0) ** | 1x (2 to 2/0) | 1x (2/0) 90°C * | 1x (2/0 to 3/0) | 1x (3/0) 90°C * | 1x (300) | 1x (300) 90°C * | 2x (3/0 to 300) | 2x (4/0 to 300) | 2x (250 to 350) | 2x (300 to 350) |
| 600 | 1x (4 to 2/0) ** | 1x (3 to 2/0) ** | 1x (2 to 2/0) | 1x (1/0 to 3/0) | 1x (3/0) | 1x (3/0) 90°C * | 1x (300) | 1x (300) 90°C * | Consult Factory | 2x (3/0 to 300) | 2x (4/0 to 300) |

*For standard enclosure, use 90°C aluminium wire. Consult Factory for Use of Conductors Rated Lower than 90°C.

** Option V659 required.

Drawing for information only.
Manufacturer reserves the right to modify this drawing without notice.
Contact manufacturer for "As Built" drawing.



| REV. | DESCRIPTION | DD/MM/YY | Drawing number |
|------|---------------------------------|----------|------------------|
| 1 | Removed Seismic logo (optional) | 18/05/22 | GPX-TD612 2/2 /E |
| 0 | First issue | 22/12/20 | |

Electric Fire Pump Controller

Model: GPX

Terminal Diagram and Sizing

Built to the latest edition of the NFPA 20 standard

Control Terminals (EB1)

Terminals Wire Size:
24 - 12 AWG
0.5 Nm

Remote Alarm Terminals (EB1)

Terminals Wire Size:
24 - 12 AWG
0.5 Nm

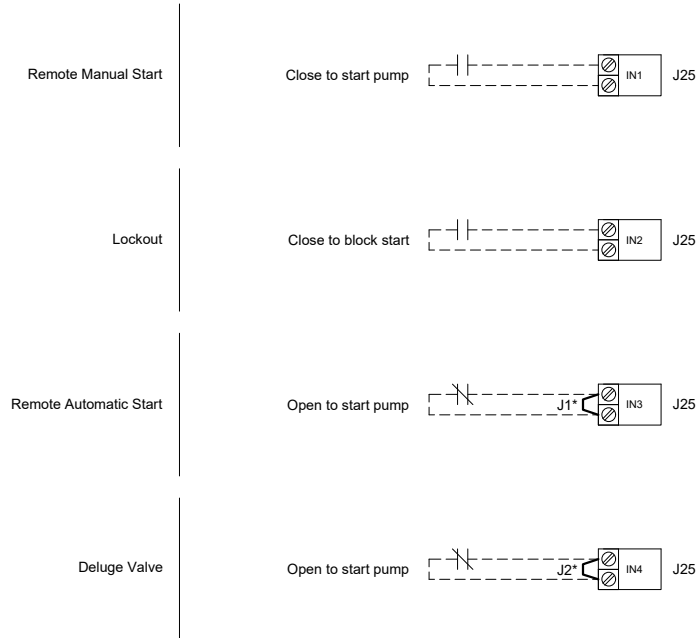

Alarm Inputs (EB1)

Terminals Wire Size:
24 - 12 AWG
0.5 Nm

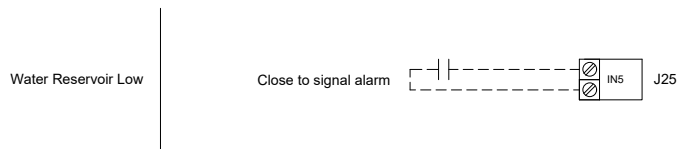

Network Connection (VMB1)

Shielded Female Connector RJ45

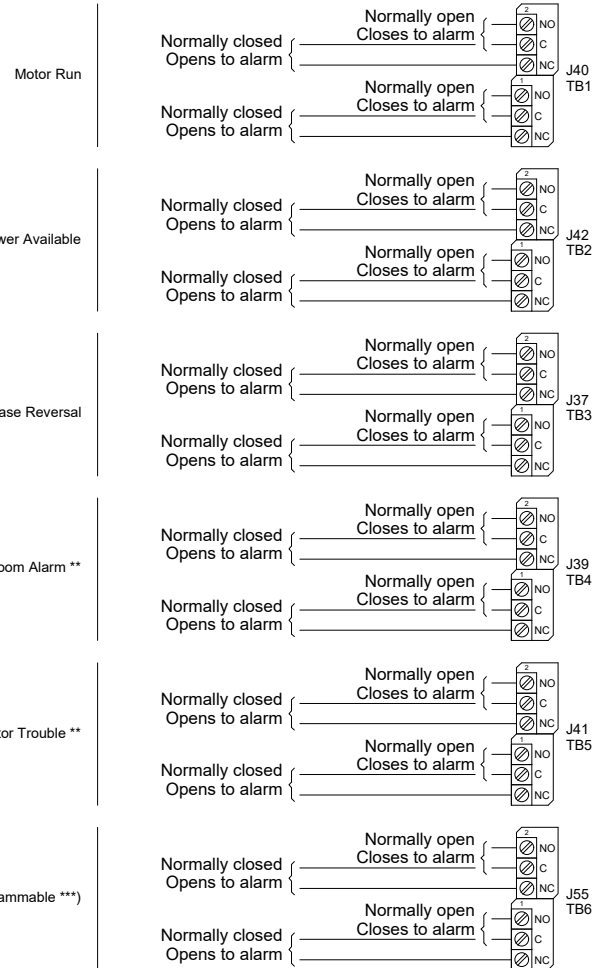

* Remove jumper to use this feature
** Re-assignable
*** Not available on GPS models

Drawing for information only.
Manufacturer reserves the right to modify this drawing without notice.
Contact manufacturer for "As Built" drawing.



| REV. | DESCRIPTION | DD/MM/YY | Drawing number |
|------|--------------------------------------|----------|----------------|
| 3 | Removed Seismic logo (optional) | 18/05/22 | GPX-TD603 / E |
| 2 | Revised logo | 18/06/18 | |
| 1 | General Revision (added AL coverage) | 10/07/17 | |