



TORNATECH

Project: _____

Customer: _____

Engineer: _____

Pump Manufacturer: _____

Technical Data
Submittal Document

HFx Series

Electric Fire Pump Controller
Built to EN17451

Contents:

Data Sheets
Dimensional Data
Wiring Schematics
Field Connections

Note: The drawings included in this package are for controllers covered under our standard offering. Actual AS BUILT drawings may differ from what is shown in this package.



April 2026

Select starting method

Model HFA Across the line

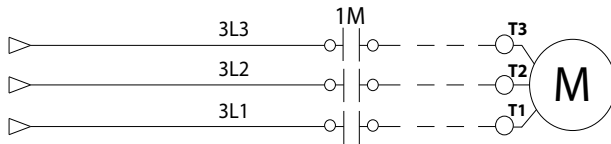

Model HFY Wye-Delta Open

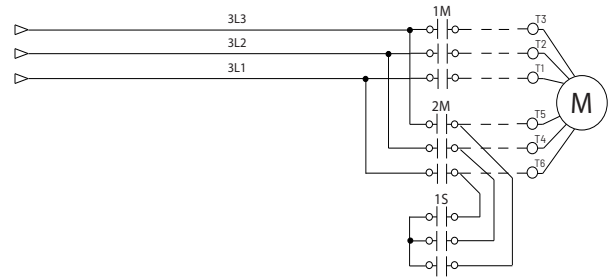

Select voltage and power rating

Voltage	Select Voltage	kW	Select kW
380V/3ph/50-60Hz		4	
400V/3ph/50-60Hz		5.5	
415V/3ph/50-60Hz		7.5	
		11	
		15	
		18.5	
		22	
		30	
		37	
		45	
		55	
		75	
		90	
		110	
		132	
		160	
		200	
		250	



Standard & Certification	Built to EN17451		
	CE Mark: Various EN, IEC & CEE directives and standards		
Enclosure	Protection Rating IP55		
	Accessories	Paint Specifications	
	<ul style="list-style-type: none"> • Bottom entry gland plate 	<ul style="list-style-type: none"> • Red RAL3002 • Powder coating • Glossy textured finish 	
Isolating Means Motor Protection	<ul style="list-style-type: none"> • Three (3) pole fused disconnect switch complete with rotary door handle <ul style="list-style-type: none"> • Fuse NH_aM (3) • Door interlocked in the ON position 		
Electrical Readings	<ul style="list-style-type: none"> • Voltage phase to phase • Amperage at L1 when motor is running 		
Pressure and Event Recorder	<ul style="list-style-type: none"> • Pressure readings with date stamp • Event recording with date stamp • Under regular maintained operation, events are stored in memory for the life of the controller. • Data viewable on operator interface display screen • Downloadable by USB port to external memory device or to App (smartphone application) 		
Terminal to Connect Starting Devices	<ul style="list-style-type: none"> • Provision to connect two (2) externally mounted pressure switches (by others) <ul style="list-style-type: none"> • Internally connected in parallel with normally open contacts when start pressure us above the desired start pressure • Contacts close when pressure loss occurs 		
Visual Indications and Audible Alarm	<ul style="list-style-type: none"> Visual indication • AC Supply Healthy • Pump Running • Pump on Demand • Time and Date stamp • Pump Room Temperature (°C or °F) 	<ul style="list-style-type: none"> Visual and Audible • Pump Failed to Start 	
Remote Alarm Contacts	<ul style="list-style-type: none"> • Pump Running • Common Fault (fail safe) • Pump on Demand • Fail to Start • Field Programmable (x2 if not used by options) 		
ViZiTouch V2.1 Operator Interface	<ul style="list-style-type: none"> • Embedded microcomputer with software PLC logic • 7.0" color touch screen (HMI technology) • Upgradable software • Multi-language 		
Operation	Automatic Start	<ul style="list-style-type: none"> • Start on pressure drop (pressure switches by others) 	
	Manual Start	<ul style="list-style-type: none"> • Start pushbutton • Run test pushbutton • Remote start from manual device 	
	Stopping	<ul style="list-style-type: none"> • Manual with Stop pushbutton 	
	Timers	Field Adjustable & Visual Countdown	<ul style="list-style-type: none"> • Minimum run period time (off delay) • Sequential start timer (on delay) • Manual test timer



Options

D14	Anti-condensation heater & thermostat
I01	Permanent isolation controller for direct on line start (CPI)
I02	Manu off auto key selector switch
I03	Permanent isolation controller for y-delta start (CPI)

L01	Other language and English (bilingual)
L02	French
L03	Spanish
L04	German
L05	Italian
L06	Polish
L07	Romanian
L08	Hungarian
L09	Slovakian
L10	Croatian
L11	Czech
L12	Portuguese
L13	Dutch
L15	Turkish
L16	Swedish
L21	Danish
L25	Chinese
L28	Finnish
L29	Norwegian

Note: Options chosen from this page are not electrically represented on the wiring schematics in this submittal package

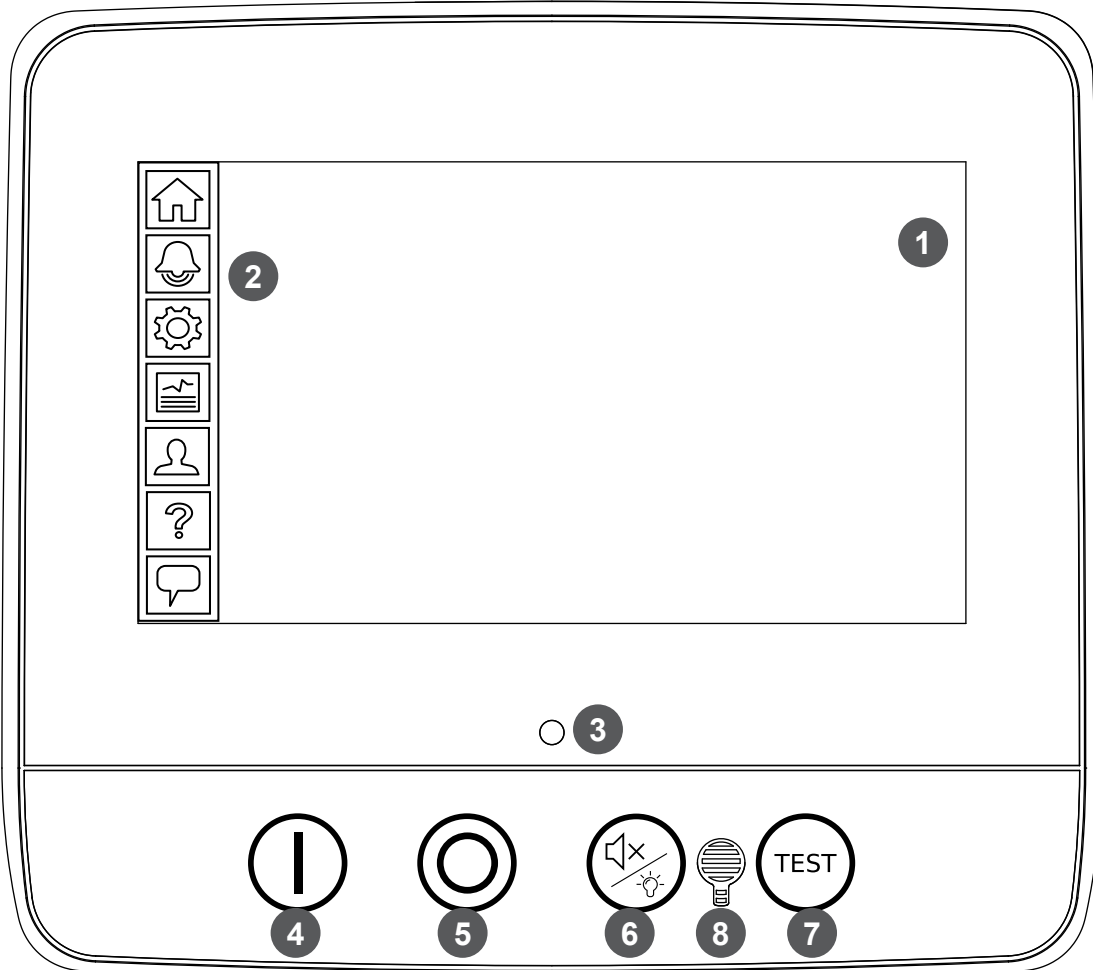
ViZiTouch V2.1 Operator Interface

- | | |
|------------------------|--------------------------------|
| 1 - Color touch screen | 3 - Power LED (3 colors) |
| 2 - Onscreen menu | 4 - START button |
| • HOME page | 5 - STOP button |
| • ALARM page | 6 - SILENCE / LAMP test button |
| • CONFIGURATION page | 7 - Run TEST button |
| • HISTORY page | 8 - Alarm buzzer |
| • SERVICE page | |
| • MANUAL page | |
| • LANGUAGES page | |



© Tornatech, Inc. Not for construction.
Subject to change without notice.

	BY	DD/MM/YY
DRAWN BY	PY	01/03/24
FINAL APPROVAL	GT	23/02/23

ELECTRIC FIRE PUMP CONTROLLER REDUCED VOLTAGE / WYE DELTA (OPEN TRANSITION)

MODEL: HFY

BUILT TO THE LATEST EDITION OF THE EN 17451 STANDARD



THIRD ANGLE
PROJECTION

DRAWING NUMBER	HFY-D1928/E
DWG REV. 0	
SHEET 1 OF 1	

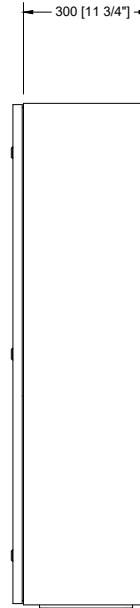
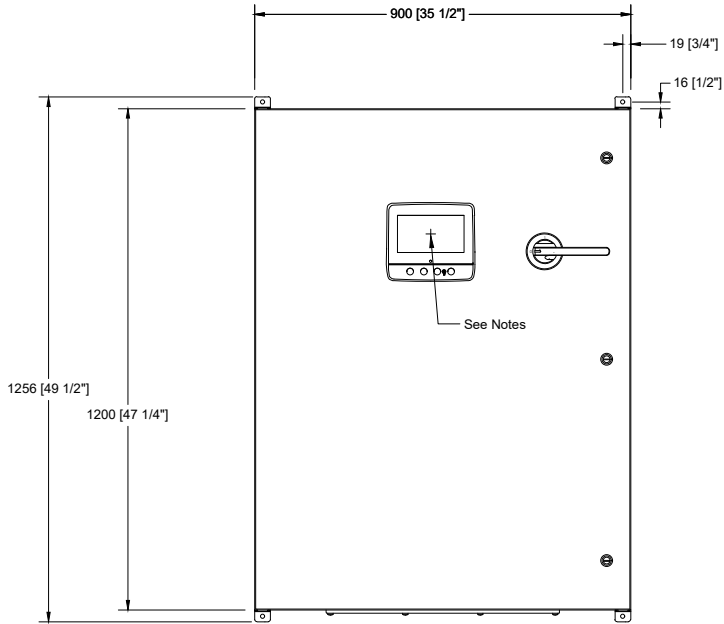

Power Table		
Voltage	Min	Max
400	110 kW	200 kW

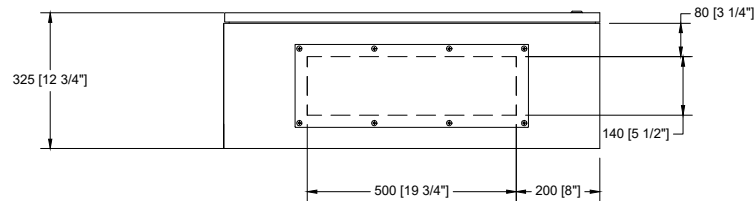

Notes:

- Standard: IP55
- Standard paint : textured red RAL 3002.
- All dimensions are in millimeters [inches].
- Center of screen: 900 [35-1/2"] from bottom.
- Bottom conduit entrance through removable gland plate recommended.
- Use watertight conduit and connector only.
- Protect equipment against drilling chips.
- Door swing equal to door width.



© Tornatech, Inc. Not for construction.
Subject to change without notice.

BY		DD/MM/YY
DRAWN BY	DDS	01/03/24
FINAL APPROVAL	GC	01/03/24

ELECTRIC FIRE PUMP CONTROLLER REDUCED VOLTAGE / WYE DELTA (OPEN TRANSITION)

MODEL:HFY

BUILT TO THE LATEST EDITION OF THE EN 17451 STANDARD



DRAWING NUMBER	HFY-WS920/E
DWG REV. 1	
SHEET 1 OF 2	

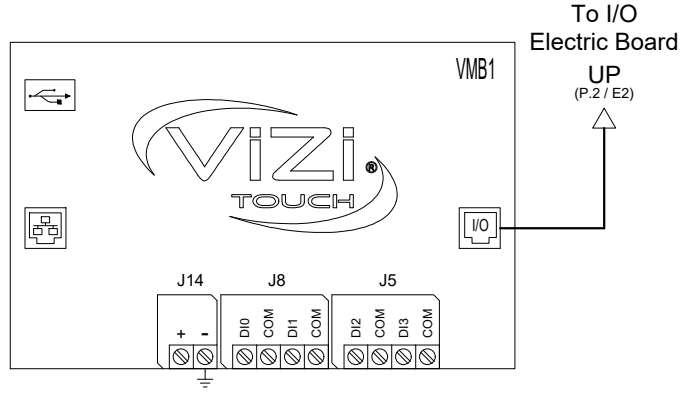
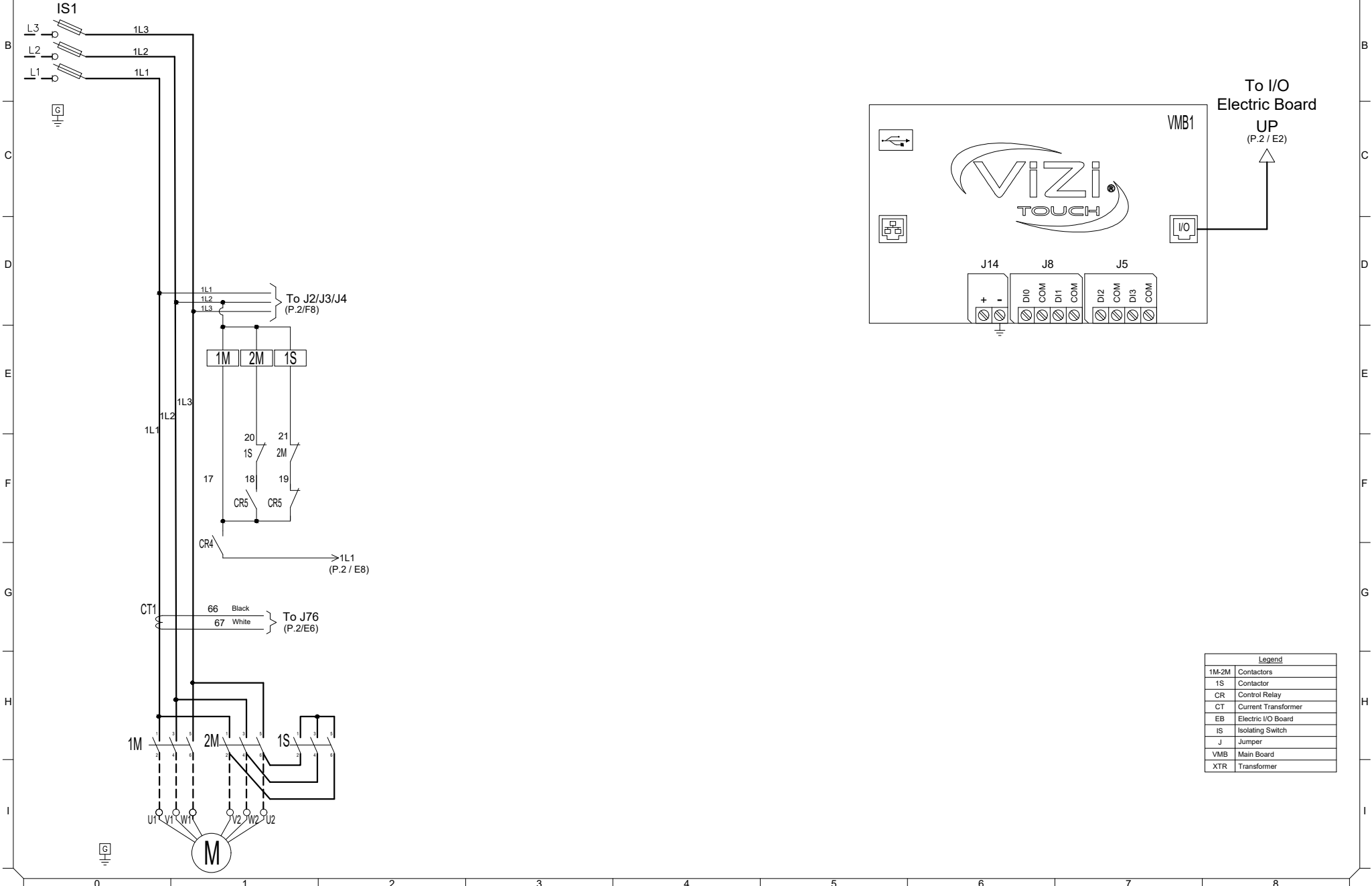

Legend	
1M-2M	Contactors
1S	Contactor
CR	Control Relay
CT	Current Transformer
EB	Electric I/O Board
IS	Isolating Switch
J	Jumper
VMB	Main Board
XTR	Transformer



© Tornatech, Inc. Not for construction.
Subject to change without notice.

BY		DD/MM/YY
DRAWN BY	DDS	01/03/24
FINAL APPROVAL	GC	01/03/24

ELECTRIC FIRE PUMP CONTROLLER REDUCED VOLTAGE / WYE DELTA (OPEN TRANSITION)

MODEL:HFY

BUILT TO THE LATEST EDITION OF THE EN 17451 STANDARD



DRAWING NUMBER	HFY-WS920/E
DWG REV.	1
SHEET 2 OF 2	

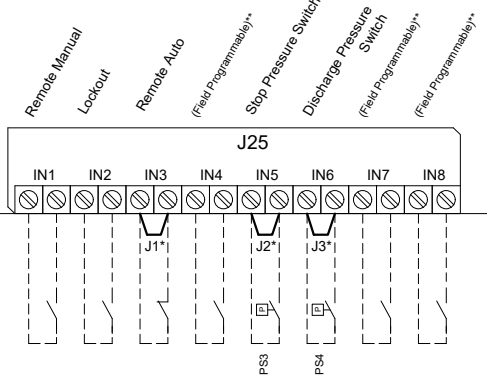
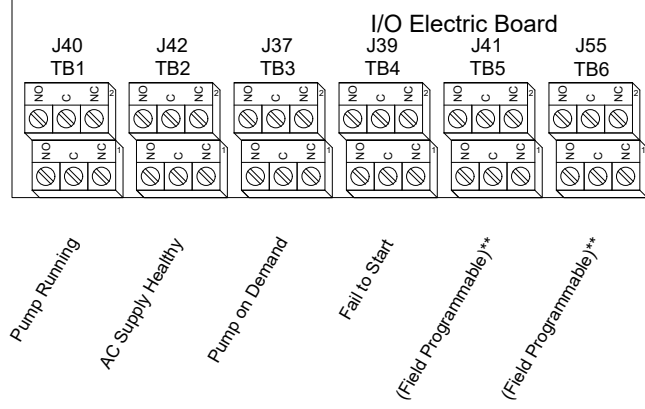
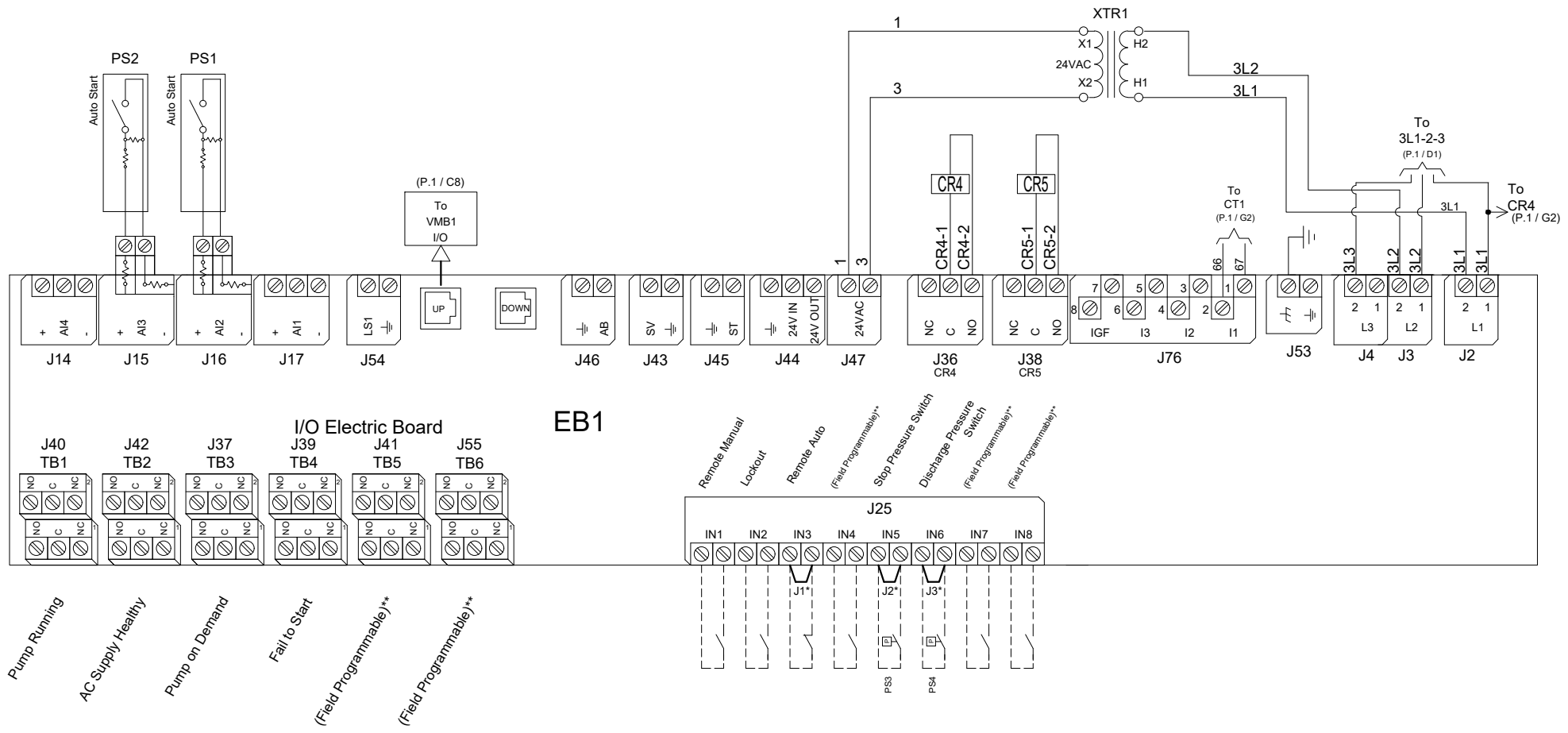

* Remove jumper to use this feature
** It could be occupied when options added



© Tornatech, Inc. Not for construction.
Subject to change without notice.

BY	DD/MM/YY
DRAWN BY	DDS 20/03/26
FINAL APPROVAL	GC 20/03/26

ELECTRIC FIRE PUMP CONTROLLER REDUCED VOLTAGE / WYE DELTA (OPEN TRANSITION)

MODEL:HFY

BUILT TO THE LATEST EDITION OF THE EN 17451 STANDARD



DRAWING NUMBER	HFY-TD925/E
DWG REV. 2	
SHEET 1 OF 1	

Field Connections

Normal Power Connection

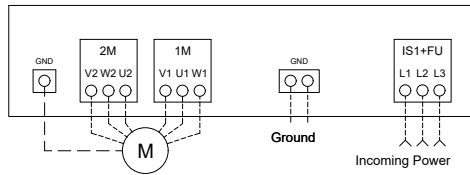

Field Connections

Terminals Wire Size:
0.5 mm² - 4mm²
0.5 Nm

- Remote Manual
- Lockout
- Remote Auto
(Field Programmable)**
- Stop Pressure Switch
- Discharge Pressure Switch
(Field Programmable)**
- (Field Programmable)**

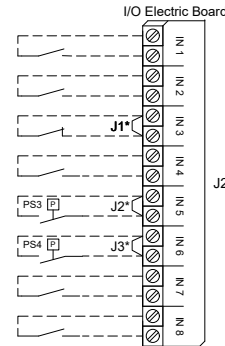

Alarm Contacts

Terminals Wire Size:
0.5 mm² - 4mm²
0.5 Nm

- Pump Running
- Common Fault (Failsafe)
- Pump on Demand
- Fail to Start
- (Field Programmable)**
- (Field Programmable)**

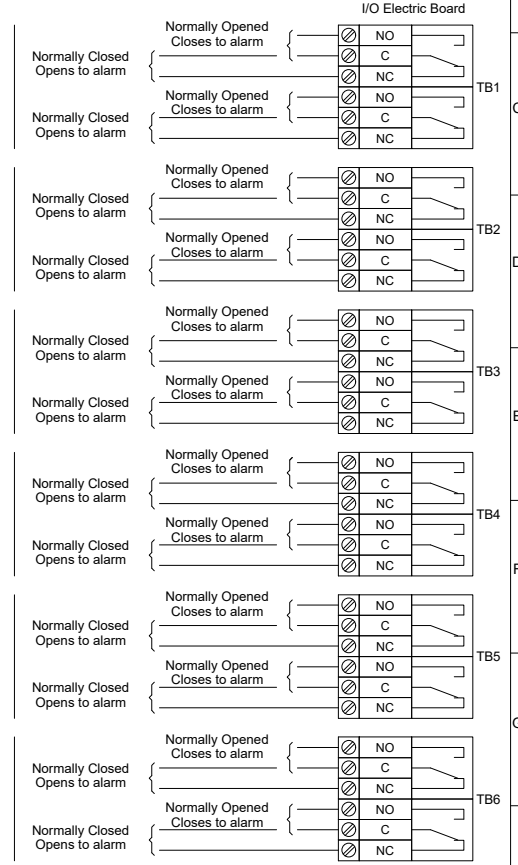

Network Connections

Terminals Wire Size:
Shielded Female Connector RJ45

Modbus TCP/IP RJ45

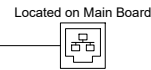

Field Connections

Terminals Wire Size:
0.5 - 4 mm²
0.5 Nm

Pressure Switch 1***

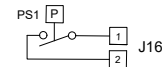

Pressure Switch 2***

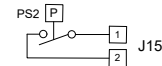

* Remove jumper to use this feature
** It could be occupied when options added

*** Shielded cable required. Shield must be grounded on the opposite side of the controller.